

# 42" Packaged Terminal AC/HP

Our 42" packaged terminal air conditioners and heat pumps provide year 'round comfort, room by room, for hotels, motels, apartments, office buildings, schools, nursing homes and more. Designed for quick installation in most 16" x 42" wall sleeves, they're great for new construction as well as replacements.

Combining attractive appearance with state-of-the-art technology, these units minimize energy usage while ensuring guest comfort. Available in cooling only and heat pump versions, all models include electric heat as standard.

For installation flexibility, the unit is designed to be controlled either by on-board control panel or by a wired remote thermostat. A plug-in adapter for this thermostat is included. The unit can also be set up for a wireless thermostat or front desk control with easy-to-connect interface.

All functions of the unit can be controlled in-room using the easy-to-understand touchpad. LEDs correspond to mode and fan operation, indicating unit status, and the setpoint

## FEATURES

- **Standard Efficiency**—Provides energy efficiency and economy of cost in a streamlined and attractive modern design showcasing state-of-the-art features.
- **Environmentally Friendly**—Our packaged terminal units come charged with the environmentally friendly R-32 refrigerant
- **Room Freeze Protection**—When the unit senses temperatures 50°F or lower for three minutes, heat pump models automatically activate the heating mode
- **Versatile Configuration**—The unit can be optimized to a specific application through the use of dipswitches and the digital keypad; selections include setpoint limiting, front desk control, wall thermostat control, and more
- **Quiet Operation**—Indoor sound reduction is achieved through the unit's two permanently lubricated fan motors; compressor has rubber grommet mounting
- **Fresh Air Control Arm**—Allows outdoor air into room through filtered vent, 85 CFM
- **Easy To Service**—On-board computer diagnostics help prolong the life of the unit and simplify service; LED indicator flashes error codes
- **Seacoast models**—with corrosion resistant components, see specifications inside

## PACKAGED TERMINAL AC/HP

**PTAC - Cooling only with electric heat**

**PTHP - Heat pump with electric heat**

*7,000 to 15,000 BTUH*



*Comfort-Aire*®

## Warranty

5 years on compressor, 5 year on parts  
See warranty document for details or visit [www.comfort-aire.com](http://www.comfort-aire.com)

## MODEL NOMENCLATURE

P T	A C	1 2	G	1	3 0	A
Package Terminal Unit with Electric Heat	AC = Cooling Only HP = Heat Pump	Capacity BTUH x 1000	Source Code	Power 1 = 208/230-1-60 2 = 265-1-60	Electric Heat 30 = 3.0 kW 50 = 5.0 kW	Series/ Revision

## PERFORMANCE AND ELECTRICAL DATA

### 208/230V COOLING ONLY WITH ELECTRIC HEAT

FEATURE	PTAC07G130A	PTAC09G130A	PTAC12G130A	PTAC12G150A	PTAC15G130A	PTAC15G150A
Cooling BTUH	7,000/7,200	9,100/9,300	11,800/12,000	11,800/12,000	14,300/14,500	14,300/14,500
EER	12.0/12.0	11.6/11.6	10.8/10.8	10.8/10.8	10.0/10.0	10.0/10.0
Cooling Amps	2.8/2.7	3.9/3.6	5.3/4.9	5.3/4.9	7.0/6.4	7.0/6.4
Max. Current Amps	3.6	5.2	7.7	7.7	11.0	11.0
Cooling Watts	580/600	785/800	1,090/1,110	1,090/1,110	1,430/1,450	1,430/1,450
Electric Heater kW @ 208/230	2,500/3,050	2,500/3,050	2,500/3,050	4,135/5,050	2,500/3,050	4,135/5,050
Elec. Heat BTUH @ 230V	8,300/10,200	8,300/10,200	8,300/10,200	13,900/17,000	8,300/10,200	13,900/17,000
Dehum. Pts/Hr	0.36/0.30	1.69/1.37	2.56/2.32	2.56/2.32	4.44/4.29	4.44/4.29
Power Cord	LCDI-20A	LCDI-20A	LCDI-20A	LCDI-30A	LCDI-20A	LCDI-30A
Airflow CFM	365/424	365/424	412/471	412/471	412/471	412/471
Indoor Sound Max dB(A)	39/48	39/48	46/52	46/52	48/51	48/51
Out. Sound Max dB(A)	66	66	66	66	66	66
Net Wt./Shipping Wt.	91.50/102.52	93.70/104.72	105.82/116.85	105.82/116.85	95.90/117.95	95.90/117.95

### 208/230V HEAT PUMP WITH ELECTRIC HEAT

FEATURE	PTHP07G130A	PTHP09G130A	PTHP12G130A	PTHP12G150A	PTHP15G130A	PTHP15G150A
Cooling BTUH	6,800/7,200	9,000/9,200	11,800/12,000	11,800/12,000	14,300/14,500	14,300/14,500
EER	11.9/11.9	11.4/11.4	10.6/10.6	10.6/10.6	10.0/10.0	10.0/10.0
Cooling Amps	2.8/2.7	3.9/3.6	5.3/4.9	5.3/4.9	7.0/6.4	7.0/6.4
Max. Current Amps	3.6	5.2	8.0	8.0	11.0	11.0
Cooling Watts	570/605	790/805	1,110/1,130	1,110/1,130	1,430/1,450	1,430/1,450
Heat Pump BTUH	5,800/6,000	7,800/8,000	10,200/10,400	10,200/10,400	13,200/13,600	13,200/13,600
C.O.P. @ 47°F	3.5/3.5	3.4/3.4	3.4/3.4	3.4/3.4	3.2/3.2	3.2/3.2
Heating Amps	2.5/2.3	3.2/3.0	4.3/3.9	4.3/3.9	6.0/5.5	6.0/5.5
Heating Watts	485/500	670/690	880/895	880/895	1210/1245	1210/1245
Electric Heater kW @ 208/230	2,500/3,050	2,500/3,050	2,500/3,050	4,135/5,050	2,500/3,050	4,135/5,050
Elec. Heat BTUH @ 230V	8,300/10,200	8,300/10,200	8,300/10,200	13,900/17,000	8,300/10,200	13,900/17,000
Power Cord	LCDI-20A	LCDI-20A	LCDI-20A	LCDI-30A	LCDI-20A	LCDI-30A
Dehum. Pts/Hr	0.36/0.30	1.69/1.37	2.56/2.32	2.56/2.32	4.44/4.29	4.44/4.29
Airflow CFM	365/424	365/421	412/471	412/471	412/471	412/471
Indoor Sound Max. dB(A)	39/48	39/48	46/52	46/52	48/51	48/51
Out. Sound Max dB(A)	66	66	66	66	66	66
Net Wt./Shipping Wt.	92.59/103.62	94.80/105.82	95.90/117.95	95.90/117.95	108.03/119.05	108.03/119.05

# DIMENSIONS

# OPERATING VOLTAGE

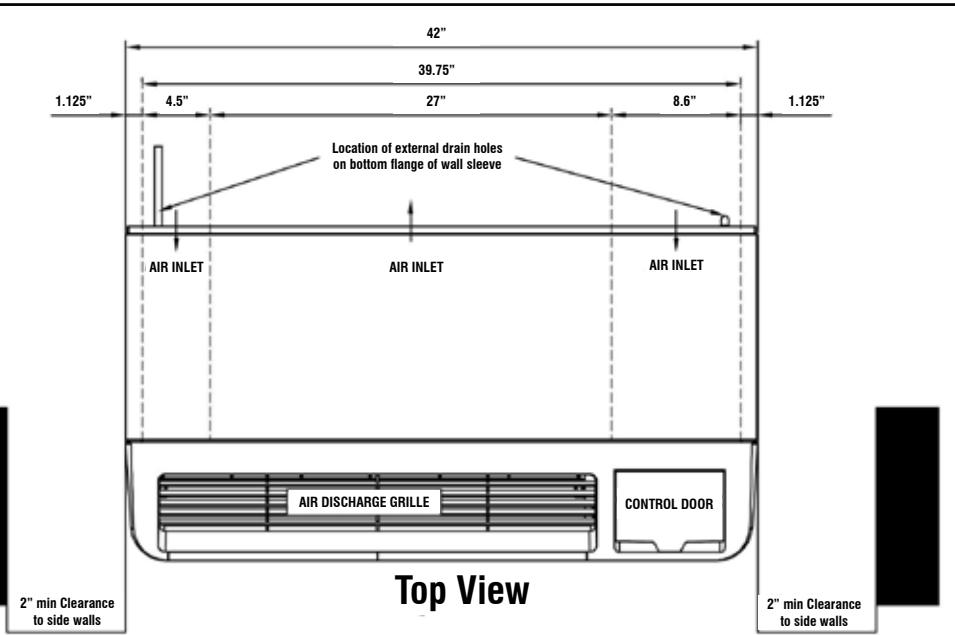

**Top View**

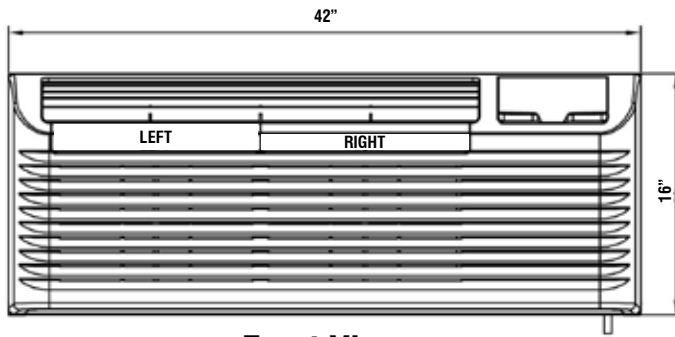

**Front View**

AIR DISCHARGE GRILLE IS REVERSIBLE TO PROVIDE EITHER 55° OR 15° DISCHARGE ANGLE

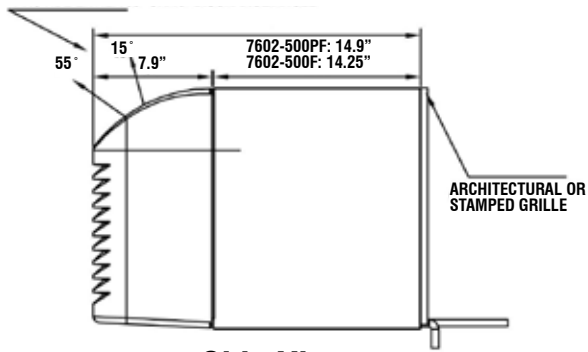

**Side View**

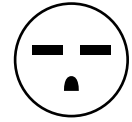

**230/208V 15 Amp**

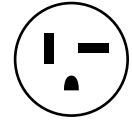

**230/208V 20 Amp**

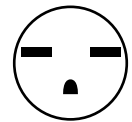

**230/208V 30 Amp**

## UNIT DIMENSIONS

42" W • 16" H • 21.1" D (without sleeve)



The two-piece filter design provides enhanced air filtration. Conveniently located on the front of the unit, filters can be easily removed for cleaning.



The fresh air control arm allows outdoor air into the room through the vent filter. Closing the vent door allows air inside the room to be circulated and filtered.

## OPERATING VOLTAGE



230/208V 15 Amp



230/208V 20 Amp



230/208V 30 Amp

## PERFORMANCE AND ELECTRICAL DATA

### 208/230V COOLING ONLY WITH ELECTRIC HEAT—SEACOAST MODELS

FEATURE	PTAC12G130ASC	PTAC12G150ASC	PTAC15G130ASC	PTAC15G150ASC
Cooling BTUH	11,800/12,000	11,800/12,000	14,300/14,500	14,300/14,500
EER	10.8/10.5	10.8/10.5	10.0/10.2	10.0/10.2
Cooling Amps	5.4/5.1	5.4/5.1	7.0/6.4	7.0/6.4
Max. Current Amps	7.3	7.3	8.9	8.9
Cooling Watts	1100/1140	1100/1140	1450/1470	1450/1470
Electric Heater kW @ 208/230	3.0	5.0	3.0	5.0
Elec. Heat BTUH @ 230V	10236	17060	10236	17060
Dehum. Pts/Hr	2.32	2.32	3.59	3.59
Power Cord	20A 6-20 P	30A 6-30 P	20A 6-20 P	30A 6-30 P
Airflow CFM	405/333	405/333	405/370	405/370
Indoor Sound Max dB(A)	48/42	48/42	48/45	48/45
Out. Sound Max dB(A)	66	66	66	66
Net Wt./Shipping Wt.	108/121	108/121	112/126	112/126

For installations in or near coastal locations, 12,000 and 15,000 BTUH models are available in a "Seacoast" version built to withstand such extreme conditions. Corrosion resistant coatings are applied to components, including the condenser fins, outdoor fan motor enclosure, base pan, and back grille. Additional corrosion protection is provided by stainless steel screws and aluminum end plates.

Treated outdoor sections successfully meet 48-hour salt spray test requirements, as well as anti-rust testing.

Seacoast models meet the same stringent performance specifications as all our PTACs/PTHPs, and are designated by "SC" at the end of the part number.

### 208/230V HEAT PUMP WITH ELECTRIC HEAT—SEACOAST MODELS

FEATURE	PTHP12G130ASC	PTHP12G150ASC	PTHP15G130ASC	PTHP15G150ASC
Cooling BTUH	11,800/12,000	11,800/12,000	14,300/14,500	14,300/14,500
EER	10.6/10.5	10.6/10.5	10.0/10.2	10.0/10.2
Cooling Amps	5.4/5.1	5.4/5.1	6.8/6.3	6.8/6.3
Max. Current Amps	7.3	7.3	8.9	8.9
Cooling Watts	1100/1140	1100/1140	1400/1420	1400/1420
Heat Pump BTUH	10,800/11,000	10,800/11,000	13,200/13,600	13,200/13,600
C.O.P. @ 47°F	3.50/3.30	3.50/3.30	3.30/3.30	3.30/3.30
Heating Amps	4.5/4.2	4.5/4.2	5.6/5.2	5.6/5.2
Heating Watts	900/950	900/950	1155/1180	1155/1180
Electric Heater kW @ 208/230	3.0	5.0	3.0	5.0
Elec. Heat BTUH @ 230V	10236	17060	10236	17060
Power Cord	20A 6-20 P	30A 6-30 P	20A 6-20 P	30A 6-30 P
Dehum. Pts/Hr	2.32	2.32	3.59	3.59
Airflow CFM	405/333	405/333	405/370	405/370
Indoor Sound Max. dB(A)	48/42	48/42	48/45	48/45
Out. Sound Max dB(A)	66	66	66	66
Net Wt./Shipping Wt.	110/123	110/123	112/126	112/126



## FEATURES

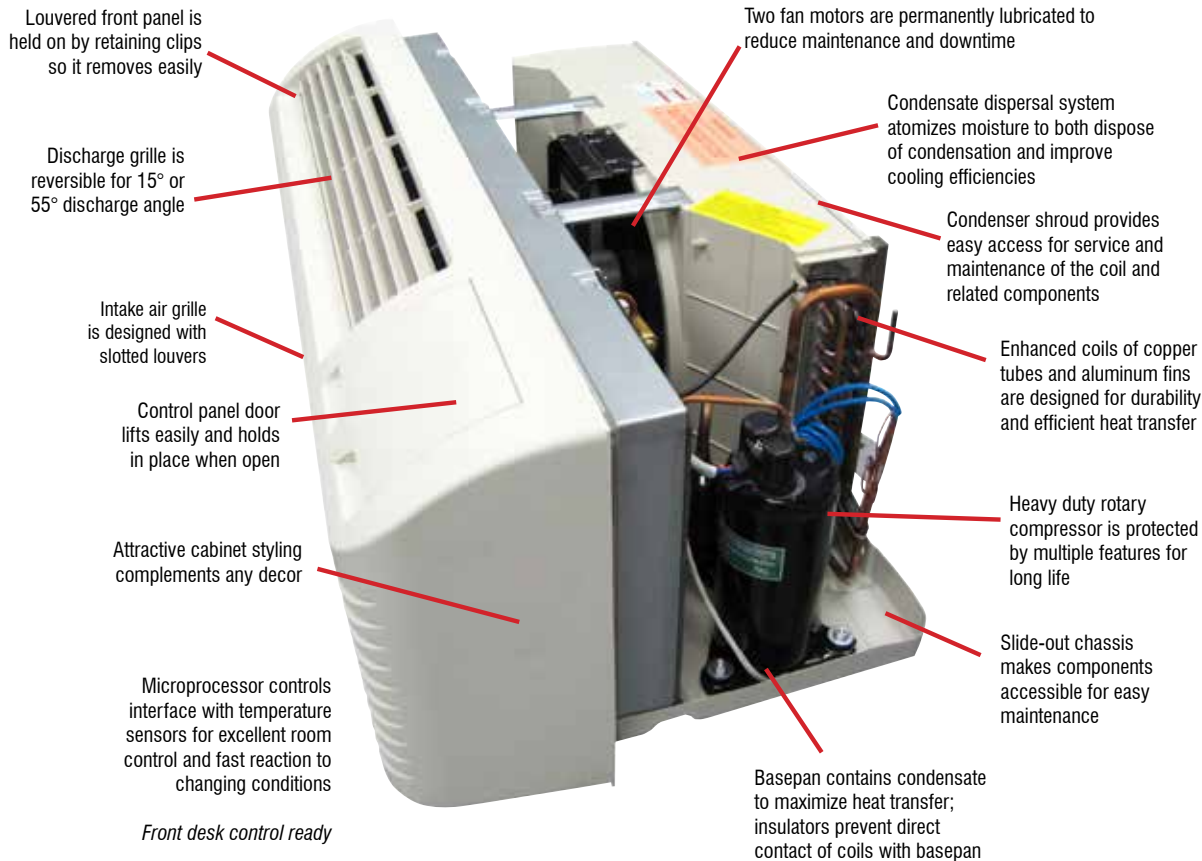

## OUTSTANDING WARRANTY COVERAGE

All Comfort-Aire PTACs/PTHPs are covered by a one year parts and labor warranty. In addition, the sealed system and all functional parts are warranted to be free from defects in material and workmanship for a total of five years. See our website for warranty details.

## PTAC/PTHP ACCESSORIES

### Breakdown Wall Sleeve

*Part No. 7602-500F - Galvanized Steel*

*Part No. 7602-500PF - Polymer*

Our 42" wall sleeve is constructed from galvanized steel and powder coated for durability and aesthetic appeal. The wall sleeve is insulated and factory spot welded to minimize breaches in the cabinet surface. It contains four chassis mounting holes, four grille mounting holes and two drain holes for optional drain kit.

**Dimensions W x H x D (inches)**

42" x 16" x 14<sup>7</sup>/<sub>8</sub>"



### Air Deflector

*Part No. 7602-508F*

The PTAC Air Deflector directs air up and away from overhanging drapes. It saves energy by eliminating trapped air flow between the window and the curtain while increasing guest comfort levels. It is easy to install with no tools needed.



# PTAC/PTHP ACCESSORIES

## Sub Base

**Part No. 7602-509F - Unpowered**

**Part No. 7602-509F-20A - 20 Amp Receptical**

**Part No. 7602-509F-30A - 30 Amp Receptical**



Made from galvanized steel and powder coated, our sub-base has only one piece, plus the skirting, for faster and more economical installation. Each kit contains: Sub-base main body, left and right side skirt, adjusting feet, and installation instructions.

### Dimensions W x H x D (inches)

42<sup>3</sup>/<sub>8</sub>" x 3<sup>3</sup>/<sub>4</sub>" x 4<sup>5</sup>/<sub>8</sub>"

## Stamped Grille

**Part No. 7602-501F**

Our stamped grille is made from durable, light weight aluminum and made to fit a standard 42" wall sleeve. Vents match our units to facilitate proper airflow, and must used with Comfort-Aire® PTACs.



*Grilles match our units to facilitate proper airflow, and must used with Comfort-Aire® PTACs.*

### Dimensions W x H x D (inches)

41<sup>7</sup>/<sub>8</sub>" x 15<sup>3</sup>/<sub>8</sub>" x 3<sup>3</sup>/<sub>8</sub>"

## Architectural Grille

**Part No. 7602-505F**

Our architectural grille fits a standard 42" wall sleeve. It's formed from durable aluminium for weight reduction and weather resistance and powder coated for greater durability. Louvers are connected with high tensile rods. The grille comes factory assembled and includes four attachment points and two discharge air shaping deflectors.



*Grilles match our units to facilitate proper airflow, and must used with Comfort-Aire® PTACs.*

### Dimensions W x H x D (inches)

42" x 15<sup>3</sup>/<sub>4</sub>" x 1<sup>3</sup>/<sub>8</sub>"

## Polymer Grille

Full polymer grille with stainless steel hardware is ideal for any location where corrosion is an issue, especially coastal areas. Available in white, beige, alpine beige, and dark bronze.

### Dimensions W x H x D (inches)

42" x 15<sup>7</sup>/<sub>8</sub>" x 1<sup>1</sup>/<sub>8</sub>"

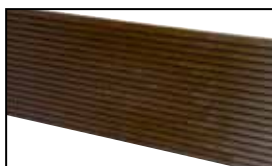

**Ultra White: 7602-505UWF**

**Beige: 7602-505PBF**

**Dark Bronze: 7602-505PDF**

**Alpine Beige: 7602-505PAF**

**White: 7602-505PWF**

**Photos may not portray actual color.**

*Grilles match our units to facilitate proper airflow, and must used with Comfort-Aire® PTACs.*

# PTAC/PTHP ACCESSORIES

## PTAC Remote Control

**Part No. 7602-512**

Designed to operate with our PTAC/PTHP models, this remote controls mode, temperature, fan speed, and has timer function.

**Dimensions W x H x D (inches)**

1<sup>7</sup>/<sub>8</sub>" x 5" x 1"



---

## Thermostat

**Part No. 7800-200 - used with PTAC**

**Part No. 7800-201 - used with PTHP**

This thermostat is a digital, mercury free, wired, non-programmable, electronic thermostat, compatible with PTAC/PTHP models.

**Dimensions W x H x D (inches)**

4<sup>1</sup>/<sub>2</sub>" x 3<sup>3</sup>/<sub>4</sub>" x 1<sup>1</sup>/<sub>16</sub>"



---

## Wireless Wall Thermostat

**Part No. 7602-536A**

This thermostat operates our PTAC/PTHP line, without the need to run control wires. Contains all basic thermostat functions.

**Dimensions W x H x D (inches)**

4<sup>5</sup>/<sub>8</sub>" x 3<sup>3</sup>/<sub>4</sub>" x 1"



---

## Lock Cover

**Part No. 7602-535**

Designed for use with duct kits, where control access is not available, or any situation where wired or wireless remote system control is desired or restricted access is required. Key access is provided for service.

**Shipping Dimensions W x H x D (inches)**

7<sup>7</sup>/<sub>8</sub>" x 7<sup>7</sup>/<sub>8</sub>" x 2<sup>1</sup>/<sub>64</sub>"



---

## Drain Kit

**Part No. 7602-506F**

The drain kit, including both 90° drain tube and a 180° drain tube, can be used for either an internal or external drain and can be attached to one of two available outlets on the wall sleeve. The mounting plates are made from galvanized steel and powder coated to match the wall sleeve.

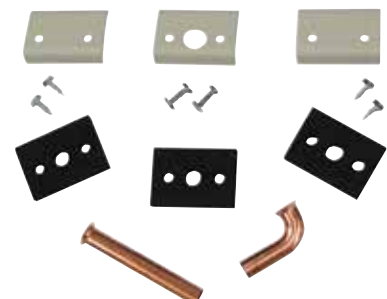

## PTAC/PTHP ACCESSORIES

### Main Duct Kit

Part No. 7602-511F

The lateral duct kit contains everything needed to convert a PTAC or PTHP for heating/cooling an adjacent room. The one-piece plenum attaches to the wall sleeve with brackets (included) and fits over the unit's air discharge grille. The extension duct can be installed for left or right side duct applications, with a maximum extension of 4 feet. Both the plenum and the duct extension are constructed of galvanized steel with a painted finish, and they are fully lined with insulation. The air volume baffle can be adjusted to allow a 75/25 to 80/20 airflow split between the primary and secondary (adjacent) rooms. In addition to the plenum, extension duct and brackets, the kit includes a wall register, wall trim kit, end cap, hardware and instructions.

#### Dimensions

**Plenum:** 44<sup>1</sup>/<sub>16</sub>" W x 7<sup>1</sup>/<sub>8</sub>" D x 7<sup>1</sup>/<sub>2</sub>" H (tallest point)

**Extension:** 47<sup>5</sup>/<sub>16</sub>" W x 7" D x 3<sup>1</sup>/<sub>2</sub>" H

**Wall Register:** 8<sup>1</sup>/<sub>2</sub>" W x 5<sup>1</sup>/<sub>4</sub>" H



Plenum

Duct Extension



Wall Register



Trim Kit

*Due to ongoing product improvements, specifications and dimensions are subject to change and correction without notice or incurring obligations. Determining the application and suitability for use of any product is the responsibility of the installer. Additionally, the installer is responsible for verifying dimensional data on the actual product prior to beginning any installation preparations.*

*Third party incentive and rebate programs have precise requirements as to product performance and certification. All products meet applicable regulations in effect on date of manufacture; however, certifications are not necessarily granted for the life of a product. Therefore, it is the responsibility of the applicant to determine whether a specific model qualifies for these incentive/rebate programs.*



PTAC models in this brochure are certified directly with the United States Dept. of Energy (D.O.E.) as meeting specifications shown.



"This product complies with all California product labeling laws including, but not limited to, the Safe Drinking Water and Toxic Enforcement Act of 1986, more commonly known as Proposition 65."