

INSTALLATION INSTRUCTIONS

OLFB, OLRB, OUFB

Variable Speed Oil-Fired Furnaces

This manual must be left with the homeowner for future reference.



This is a safety alert symbol and should never be ignored. When you see this symbol on labels or in manuals, be alert to the potential for personal injury or death.

WARNING

Improper installation, adjustment, alteration, service or maintenance can cause property damage, personal injury or loss of life. Installation and service must be performed by a licensed professional installer (or equivalent), service agency or the gas supplier.

WARNING

Do not store combustible materials, including gasoline and other flammable vapors and liquids, near the furnace, vent pipe, or warm air ducts. The homeowner should be cautioned that the furnace area must not be used as a broom closet or for any other storage purposes. Such uses may result in actions that could cause property damage, personal injury, or death.

CAUTION

Never burn garbage or paper in the heating system and never leave rags, paper, or any flammable items around the unit.

CAUTION

The installation of the furnace, wiring, warm air ducts, venting, etc. must conform to the requirements of the National Fire Protection Association Standard for the Installation of Oil Burning Equipment, NFPA No. 31; the National Electrical Code, ANSI/NFPA No. 70 (in the USA); the Installation Code for Oil Burning Equipment, CSA Standard CAN/CSA B139 (in Canada); the Canadian Electrical Code Part 1, CSA 22.1; the Recommendations of the National Environmental Systems Contractors Association; and any state or provincial laws or local ordinances. Local authorities having jurisdiction should be consulted before installation is made. Such applicable regulations or requirements take precedence over the general instructions in this manual.

Table of Contents

Installation	3
Start-Up	9
Sequence of Operation.....	11
Maintenance and Service	12

WARNING

This furnace is not approved for installation in a mobile home. Do not install this furnace in a mobile home. Installation in a mobile home could result in actions that could cause property damage, personal injury, or death.

Manufactured By
Comfort-Aire / Century
1900 Wellworth Ave.
Jackson, MI 49203



(P) 507148-01P

Save these instructions for future reference

OIL FURNACE START-UP CHECKLIST
(Complete this page and keep for future reference)

Customer Name _____
Address _____
City _____ **State** _____ **Zip Code** _____
Furnace Model # _____ **Serial #** _____
Input Rate _____ **Nozzle Used** _____
New Construction _____ **Replacement** _____
Date of Installation _____

Installation Data

Furnace Location:
A. Basement - Open _____ Enclosed* _____
B. Utility Room - Open _____ Enclosed* _____
C. Closet - Open _____ Enclosed* _____
D. Crawlspace - Open _____ Enclosed* _____
* Provisions must be made for adequate air for combustion. See Combustion and Ventilation Air on page 3.

Chimney Data:

A. Inside _____ Outside _____
B. Brick or Masonry _____
C. Lined _____ Size _____
D. Type: Class A All-Purpose _____ Type L _____
E. Condition _____

Flue Pipe:

A. Distance to chimney _____ Pitch _____
B. Diameter _____
C. Barometric damper installed _____
D. Drill 5/16" hole in flue pipe 12" upstream of barometric damper _____
E. Obtain drafting reading; adjust barometric _____

Oil Tank Data:

A. Installed in basement _____
B. Outside _____
C. Buried / Depth _____
D. Size _____ gallons _____
E. Age _____
F. Date of last cleaning _____

Oil Lines:

A. Size: 3/8" _____ 1/2" _____ Other _____
B. Single pipe _____ Two pipe _____
C. Distance from tank _____ Lift _____
D. Filter type _____ Inspect _____ Change _____
E. Pressure test _____
F. Recheck all fittings for tightness _____

Thermostat:

A. Type: Heating _____ Cooling _____
B. Anticipator set _____
C. Wires: New _____ Old _____

Air Filter:

A. Type: Permanent _____ Disposable _____
B. Installed _____
C. Size _____

Start-Up Procedure

A. Close disconnect switch _____
B. Set thermostat to call for heat _____
C. Bleed air from lines and pump; run for 20 seconds after bubble disappears _____
D. Install vacuum gauge; check pump vacuum _____
E. Install pressure gauge; adjust pressure to 145 or 150 psig _____
Always verify proper pump pressure to corresponding tables with instructions supplied with unit. _____
F. After 10 minutes of operation, obtain flue temperature reading:
1st _____ 2nd _____ 3rd _____
G. Obtain smoke reading
1st _____ 2nd _____ 3rd _____
H. Measure CO₂
1st _____ 2nd _____ 3rd _____
I. Check draft overfire _____ Breech _____
J. Air shutter setting _____ Locked _____
K. Measure static pressure in duct system
Static pressure on supply side _____
Static pressure on return side _____
Static pressure drop _____
L. Temperature rise after steady state conditions have been achieved
Supply side _____ Return side _____
M. Block off return air (limit control checkout); burner should shut down in 2 or 3 minutes _____

Owner Record

Installed by: _____
Dealer _____
Address _____

Telephone # _____
License # _____

Manufactured By
Comfort-Aire / Century
1900 Wellworth Ave.
Jackson, MI 49203

These checks or tests are required for all oil units.

Installation

Read all instructions before starting work so installation will conform to Underwriters' Laboratories or Canadian Standards Association requirements. The furnace must be level when placed on its foundation (upflow, counterflow, and basement models) or in its suspended position (horizontal models). Using a carpenter's level, check the furnace in at least two directions. The weight must be distributed evenly before the duct work is attached.

These instructions must be placed on or near the furnace in a conspicuous place.

Inspection of Shipment

This furnace is shipped in one package, completely assembled and wired. The thermostat is shipped in a separate carton when ordered.

Upon receipt of equipment, carefully inspect it for possible shipping damage. If damage is found, it should be noted on the carrier's freight bill. Damage claims should be filed with the carrier immediately. Claims of shortages should be filed with the seller within 5 days.

Location

Locate the furnace as centrally as possible so that all warm pipes to the various rooms are nearly the same length. This allows each room to receive an equal and proper amount of heat. This may vary with each particular installation.

Position the furnace so the pipe connection to the chimney will be of minimum distance and have a minimum of fittings.

In utility rooms or similar installations, the door or access opening should be large enough to permit replacement of the furnace, or another appliance such as a water heater, without disturbing any other equipment.

WARNING

In any installation where damage from oil may occur, a drain pan must be installed. The drain pan must be large enough size to completely prevent any potential oil damage. The drain pan piping must be sized to drain the oil pump capacity and the piping must be routed to drain the oil back to the oil tank.

For attic installations, a booster oil pump may be required to supply oil to the oil burner. Check state and local codes for specific requirements.

Clearances

A minimum of 24" is recommended in front of the furnace for servicing the burner on all models.

See Table 1 for a complete listing of the minimum clearances required for basement type and upflow installations.

Combustion and Ventilation Air

Adequate provisions for combustion air, ventilation of furnace, and dilution of the gases must be made.

If the furnace is installed in a confined space and combustion air is taken from the heated space, the supply air and ventilating air must be through two permanent openings of equal area. A confined space is "a space whose volume is less than 50 cubic feet per 1000 BTU per hour of the combined input rating of all appliances installed in that space." One opening must be within 12" of the ceiling and the other within 12" of the floor. Each opening must have a minimum free area of at least 1 square inch per 1000 BTU per hour of total input rating of all appliances within the space but not less than 100 square inches.

	Basement Type Units		Hi - Boy (Upflow)	
	OLRB & OUFB		OLFB	
	87	118	87	118
Top of Plenum and Duct Work	2"	2"	2"	2"
Plenum Sides	3"	3"	3"	3"
Furnace Sides	6"*	6"***	0"	0"
Furnace Rear	24"	24"	0"	0"
From Front Door	4"	4"	4"	4"
Flue Pipe Clearance to Combustibles**	9"	9"	6"	6"
Type of Floor	Comb.	Comb.	Comb.	Comb.
Combustion Air Openings (2 required)	10" x 20"	11" x 22"	10" x 20"	11" x 22"

* A passage, suitable for a large person, shall be provided between the furnace and chimney for inspection or replacement of the flue connector when necessary. A clearance of 24" shall be allowed at the rear and on one side of the furnace for service and cleaning of the blower.

** The minimum clearance shown to the flue pipe may be reduced by using special protection permitted by local building codes and National Fire Protection Association Standards and CSA 139.

Table 1. Minimum Clearances to Combustibles – Upflow Installations

If the furnace is installed in a space within a building of tight construction, air must be supplied from outdoors. In this case, one opening shall be within 12" of the ceiling and the other within 12" of the floor. If vertical combustion ducts are run, each opening must have a free area of at least 1 square inch per 4000 BTU per hour. If horizontal combustion ducts are run, 1 square inch per 2000 BTU per hour of the total input of all appliances is required.

As supplied, the furnace is designed to use air inside the dwelling for combustion. If additional combustion air is required, installing fresh air kit ABOOT571 allows air from outside the dwelling to be brought in to the oil burner. This kit brings air into the burner through air inlet ductwork run through the furnace cabinet side panel and terminated outside the dwelling (see Figure 1). The kit includes a vacuum relief valve to guard against combustion problems associated with directly connecting oil burners to the outside.

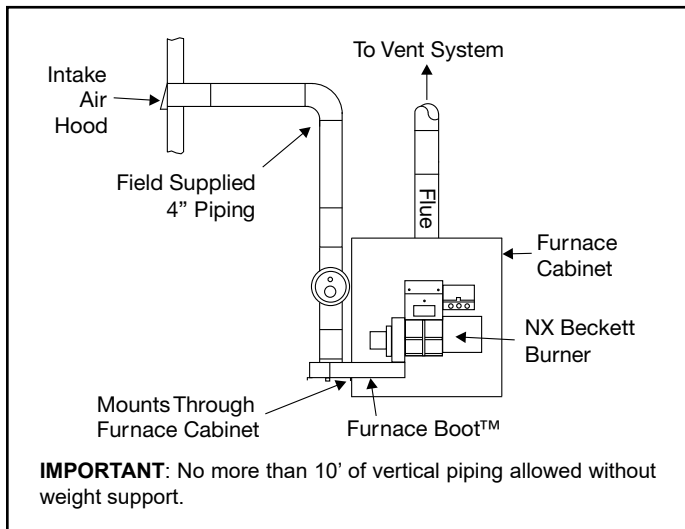

Figure 1. Fresh Air Kit ABOOT571 Installation

⚠ WARNING

Combustion air openings in the front of the furnace must be kept free of obstructions. Any obstruction will cause improper burner operation and may result in a fire hazard or injury.

⚠ WARNING

The barometric control shall be in the same atmospheric pressure zone as the combustion air inlet to the furnace. Deviation from this practice will cause improper burner operation and may result in a fire hazard or injury.

⚠ WARNING

The barometric control must be removed from the vent pipe when using a combustion air adapter. Deviation from this practice will cause improper burner operation and may allow flue products into the living space which may result in personal injury or death.

Circulating Air Supply

A return air duct system is recommended. Where there is no complete return air duct system, a return connection should be run full size to a location outside the confined space and completely sealed so that no air from the confined space can be circulated through the heating duct system.

Outdoor Make Up Air

A minimum mixed return air temperature of 60 – 65°F must be maintained for outdoor make up air to prevent condensation and corrosion.

Venting Chimney

Before installing the furnace, a thorough inspection of the chimney should be made to determine whether repairs are necessary and that the chimney is of the proper size and constructed in accordance with the requirements of the National Board of Fire Underwriters or Canadian Standards Association. The smallest dimension of the chimney should be at least equal to the diameter of the flue pipe of the furnace. Be sure the chimney will produce a steady draft sufficient to remove all the products of combustion from the furnace. A fabricated vent system the same size as the flue outlet of the furnace may also be used. If a manufactured vent is used, it must be listed for use with oil-fired equipment.

⚠ WARNING

This furnace is certified for use with Type "L" vent, Type "A", and "factory-built" chimneys. "B" vent must not be used with oil furnaces.

Vertical Venting

1. Local building codes may have more stringent installation requirements and should be consulted before installation of the unit.
2. The flue pipe should be as short as possible to do the job.
3. The flue pipe should not be smaller than the outlet diameter of the flue outlet of the furnace.
4. Single wall flue pipe should not run outside or through any unconditioned space.
5. The chimney should terminate 2' above the highest peak of a peaked roof, and 3' higher than a flat roof.
6. The flue pipe must not pass through a floor or ceiling. Clearances to single wall flue pipe should be no less than specified in Table 1.
7. The flue pipe may pass through a wall where provisions have been made for a thimble as specified in the Standards of the National Board of Fire Underwriters (see Figure 2).

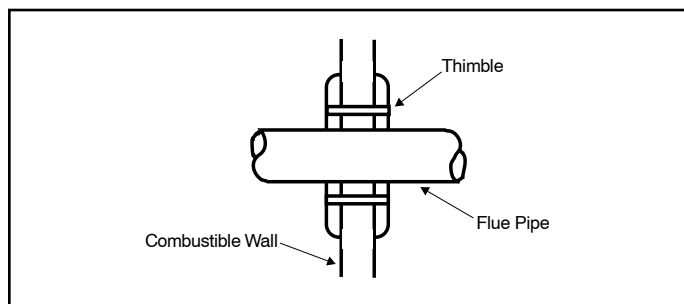

Figure 2. Wall Thimble

8. The flue pipe should slope upward toward the chimney on a horizontal run of at least 1/4" per foot and should be supported by something other than the furnace (see Figure 3 and Figure 4).
9. Extend the flue pipe into the chimney so that it is flush with the inside of the flue liner. Seal the joint between the pipe and the liner.
10. The furnace shall be connected to a factory-built chimney or vent complying with a recognized standard, or a masonry or concrete chimney lined with a lining material acceptable to the authority having jurisdiction.
11. When two or more appliances vent into a common flue, the area of the common flue should not be less than the area of the largest flue or vent connection plus 50% of the areas of the additional vents or flue connections. The chimney must be able to sufficiently vent all appliances operating at the same time.
12. The flue pipe shall not be connected to a chimney flue serving a solid fuel appliance or any mechanical draft system.
13. All unused chimney openings should be closed.

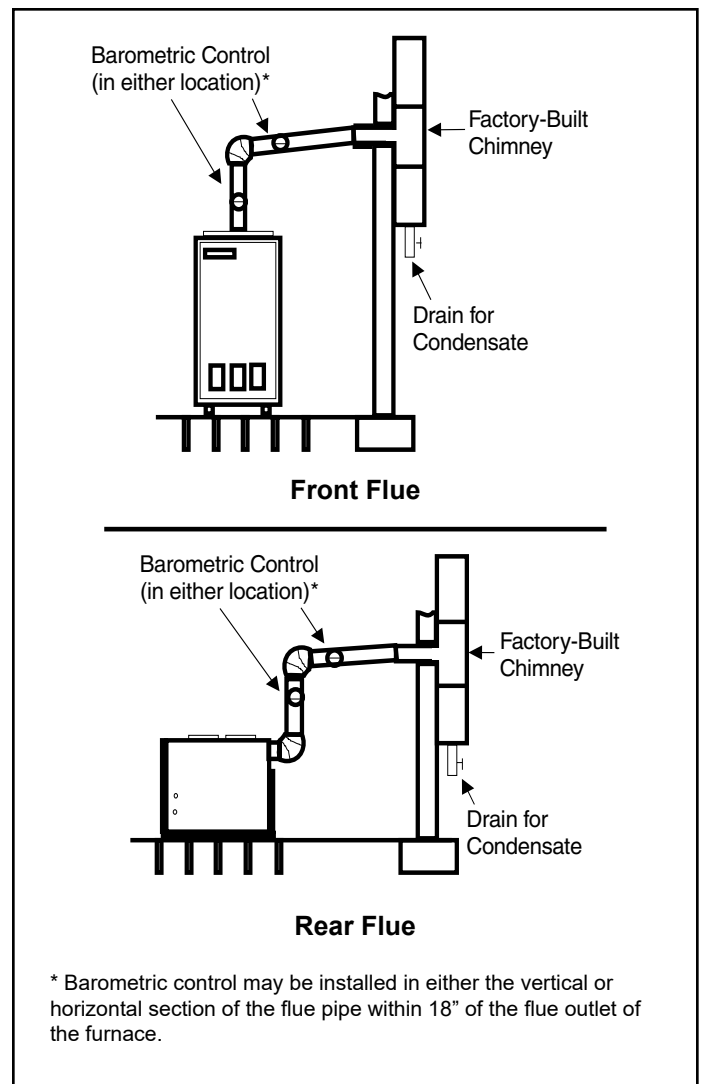

Figure 3. Factory-Built Chimney

14. All vent pipe run through unconditioned areas or outside shall be constructed of factory-built chimney sections (see Figure 3).
15. Where condensation of flue gases is apparent, the vent shall be constructed to prevent the condensation from entering the flue transition box opening. Provisions shall be made to drain off the condensate (see Figure 3).
16. Vent connectors serving this appliance shall not be connected into any portion of a mechanical draft system operating under positive pressure.
17. Keep the area around the vent terminal free of snow, ice, and debris.

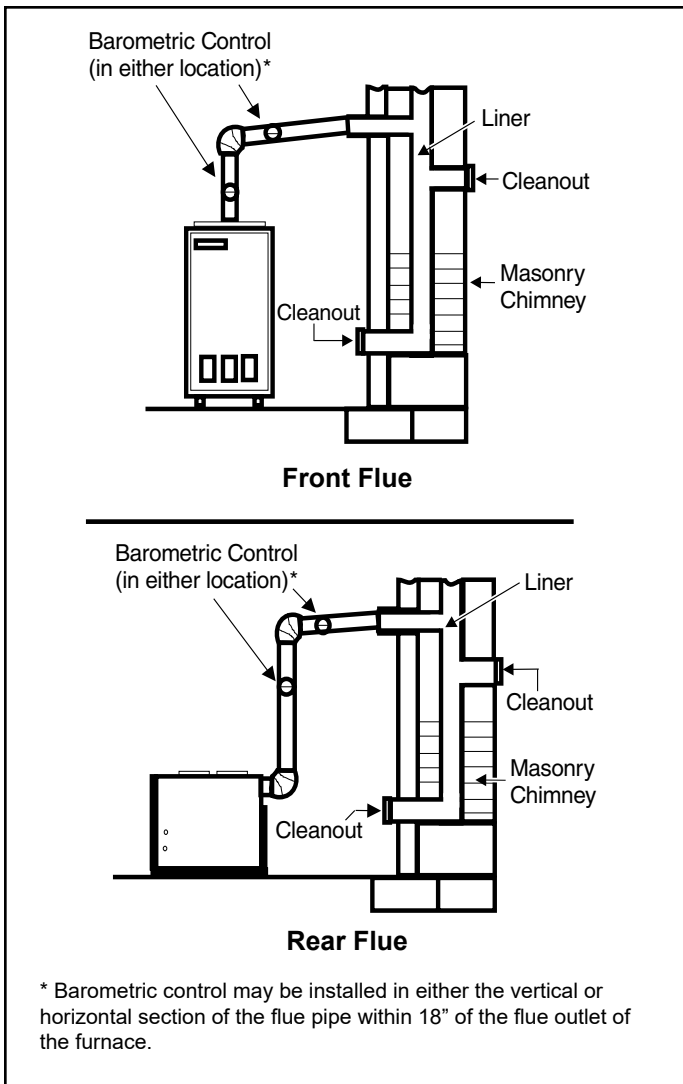

Figure 4. Masonry Chimney

Horizontal Venting

The design of this furnace has been approved for horizontal venting with the following mechanical vent systems:

Manufacturer	Model
Tjernlund (sideshot)	SS1, SSC, SS2
Field Control	SWGII-5-SS with CK61 Control Kit

Refer to the manufacturer's installation instructions for proper installation procedures and service parts information.

Vent systems are available through the local distributor.

Barometric draft control must be used in the horizontal venting (sidewall) system. It must be located within 18" of the furnace flue outlet (see Figure 5).

Do not common vent with any other appliance when using the sidewall system.

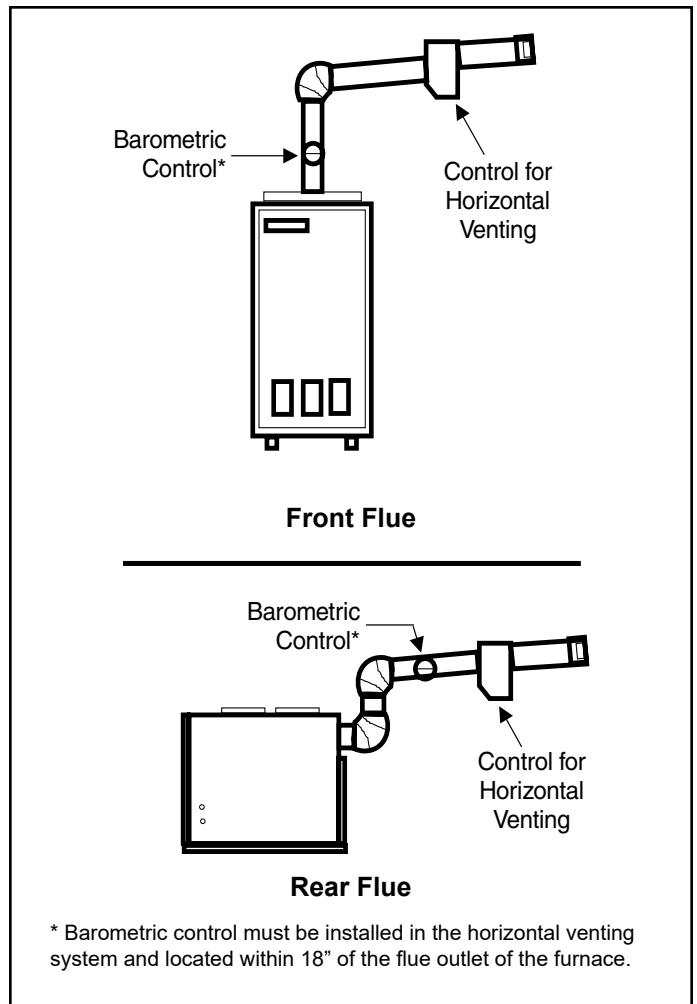

Figure 5. Horizontal Venting

Maximum permissible vent length is 100 equivalent feet, and minimum permissible length is 15 equivalent feet. Calculate the equivalent vent pipe footage from the furnace to the mechanical vent system by adding the straight vent pipe length and equivalent elbow lengths together. Each 90° elbow is equivalent to 10' of straight pipe; each 45° elbow is equal to 5' of straight pipe.

Removal of Unit from Common Venting System

When an existing furnace is removed from a common venting system serving other appliances, the venting system is likely to be too large to properly vent the remaining attached appliances. The following test should be conducted with each appliance while the other appliances connected to the common venting system are not in operation.

1. Seal any unused openings in the common venting system.
2. Visually inspect the venting system for proper size and horizontal pitch and determine there is no blockage

or restriction, leakage, corrosion, or other deficiencies which could cause an unsafe condition.

3. Insofar as is practical, close all building doors and windows between the space in which the appliances remaining connected to the common venting system are located and other spaces in the building. Turn on clothes dryers and any appliance not connected to the common venting system. Turn on exhaust fans, such as range hoods and bathroom exhausts, so they will operate at maximum speed. Do not operate a summer exhaust fan. Close fireplace dampers.
4. Following the lighting instructions, place the unit being inspected in operation. Adjust the thermostat so the appliance will operate continuously.
5. Test for spillage at the draft control relief opening after 5 minutes of main burner operation. Use the flame of a match or candle.
6. After it has been determined that each appliance remaining connected to the common venting system properly vents when tested as outlined above, return doors, windows, exhaust fans, fireplace dampers, and any other fuel burning appliance to their previous condition of use.
7. If improper venting is observed during any of the above tests, the common venting system must be corrected.

See National Fuel Gas Code, ANSI Z223.1 (latest edition) or CAN/CGA B149.1 & .2 Installation Codes to correct improper operation of common venting system.

Supply and Return Air Plenum

Secure return air plenum to unit using sheet metal screws.

Follow these procedures when installing supply air plenum:

1. Use sealing strips of fiberglass.
2. Attach the plenum to the furnace or evaporator cabinet with sheet metal screws.
3. Both supply and return air plenums shall be square and at least 18" long. They should be the same dimension as the furnace opening.
4. Install supply and return air ducts as desired.

Filters

Optional filter rack kit for Upflow units:

- R37398C001 - Sized for 24 X 16 X 1/2 filter

Basement

Permanent filters are supplied with these units. To clean the filters, shake to remove any excess dirt and/or use a vacuum cleaner. Wash with soapy detergent water and dry. The filters should be cleaned at least once a month, or more frequently in unusually dusty environments.

Never leave the access panels to the blower compartment off or partially open.

Oil Supply and Oil Filter Connection

Continuous lengths of heavy wall copper tubing or steel pipe are recommended and should be installed under the floor or near walls to protect from damage. Do not run lines on floor joists or other reverberating surfaces. Always use flare fittings located in accessible places.

Install a generous capacity oil filter inside building between the fuel shutoff valve and burner. Locate filter and valve close to burner for easy servicing. An oil filter is required for all models. A 10-micron filter is recommended.

Combustion Chamber

The combustion chamber is installed in the furnace at the factory. Read the instruction plate on the front of the unit concerning proper care of the chamber.

This combustion chamber is made of preformed ceramic fiber material. Use extreme care when installing the oil burner so that the chamber is not damaged around the burner tube.

Electrical Wiring

All wiring must conform to the National Electrical Code, the Canadian Electrical Code, and any local codes. Connect the 115-volt, single phase service to the unit at the junction box. Use a separate fused branch electrical circuit containing a properly sized fuse or circuit breaker. Run this circuit directly from the main switch box to an electrical disconnect that is readily accessible and located near the furnace. Follow carefully the wiring diagram adhered to the inside of the blower compartment door.

The electrical supply to the mechanical vent system must be supplied from the appliance. All wiring must be appropriate Class I wiring. Wiring must be installed in rigid metal conduit, intermediate metal, or be otherwise suitably protected from physical damage. Refer to the wiring diagrams supplied with the venter kit for proper electrical connections.

Thermostat

Locate the thermostat on an inside wall in a room usually occupied during the day, such as a living room or dining room, at a height of 4-1/2' from the floor. Avoid direct sunlight or supply air from a register. Make sure the location is not adjacent to appliances such as ovens or lights. Wire the thermostat with minimum of #18 AWG thermostat wire.

Continuous Blower Operation

The comfort level of the living space can be enhanced when using this feature by allowing continuous circulation of air between calls for cooling or heating. The circulation of air occurs at half the full cooling airflow rate. This can produce more even temperatures throughout the home and/or continuous operation of IAQ accessories.

To enable the continuous blower operation, place the fan switch on the thermostat into the ON position. A call for fan from the thermostat closes R to G on the blower interface board. The control waits for a 1-second thermostat debounce delay before responding to the call for fan by ramping the circulating blower up to 50% of the cooling speed. When the call for continuous fan is satisfied, the control immediately ramps down the circulating blower.

Humidifier

Terminals are provided on the control board which provides a 120-volt output to operate a humidifier. The "HUM" terminal is energized whenever the thermostat calls for heat. Refer to furnace wiring diagram for specific connection information.

Electronic Air Cleaner

Terminals are provided on the control board for connection of a 120-volt electronic air cleaner. The "EAC" terminal is energized whenever the thermostat calls for heat, cooling, or continuous blower. Refer to the furnace wiring diagram for specific connection information.

Variable Speed Features

This furnace is equipped with a variable speed circulation air blower motor that will deliver a constant airflow within a wide range of external static pressures. Other features of this variable speed motor include:

Blower Ramp Up

The variable speed motor will slowly ramp up to normal operating speed. This minimizes sound and increases comfort by eliminating the initial blasts of air encountered with standard blower motors.

Blower Ramp Down

At the end of a cooling or heating cycle, the variable speed motor will slowly ramp down. If continuous blower operation has been selected, the variable speed motor will slowly ramp down to 50% of the selected cooling CFM.

Passive and Active Dehumidification

For situations where humidity control is a problem, a dehumidification feature has been built into the variable speed motor. At the start of each cooling cycle, the variable speed motor will run at 82% of the rated airflow for 7.5 minutes. After 7.5 minutes has elapsed, the motor will increase to 100% of the rated airflow.

To achieve additional dehumidification, remove the dehumidify jumper located at the bottom right of the blower interface board (see Table 3) and connect a humidity control that opens on humidity rise to the HUM and R terminals. The HUM terminal on the blower interface board must be connected to the normally closed contact of the humidity control so that the board senses an open circuit on high humidity. In this setup, the variable speed motor will operate at 82% of the normal cooling airflow rate whenever there is a call for dehumidification. When the relative humidity has been brought down to an acceptable level, the cooling blower speed will return to 100% of design.

Circulating Airflow Adjustments

Cooling Mode

The units are factory set for the nominal airflow for each model. Adjustments can be made to the cooling airflow by changing the position (A, B, C, or D) of the jumper plug on the tap marked COOL (on the blower interface board) based on the information provided in Table 3. To determine what CFM the motor is delivering at any time, count the number of times the LED labeled CFM on the blower interface board flashes. Each flash signifies 100 CFM; count the flashes and multiply by 100 to determine the actual CFM delivered (for example: 10 flashes x 100 = 1000 CFM).

Moving the jumper plug on the tap marked ADJUST from the NORM position to the (+) or (-) position will increase or decrease the cooling airflow (Y or O call) by 15%. Changing the position of the ADJUST jumper plug does not affect heating airflow except if a heat pump is used in conjunction with the oil furnace. If a heat pump is used, moving the ADJUST jumper plug to the (+) or (-) position will increase or decrease the airflow by 15% when operating in all heat pump modes, but will not affect heating airflow when the oil furnace is used for heating.

For single stage cooling, jumper Y1 and Y2 to obtain rated cooling CFM. In two stage cooling configuration, Y1 will produce 70% of rated cooling CFM and Y2 will produce 100%.

Heating Mode

The unit as shipped is factory set to run at the middle of the heating rise range as shown on the unit rating plate. The jumper plug on the tap marked HEAT should remain in the position (A, B, C, or D) listed in the HEAT Setting column found in Table 3.

ADJUST*, HEAT, and COOL Taps (on Blower Interface Board)											
* Placing ADJUST jumper plug in the TEST position energizes the motor to a default factory setting. This can be used to determine if the motor is operating properly. Test pin function is enabled during any mode of thermostat call. If no thermostat call is present, test function is disabled. The ADJUST jumper plug must be returned to original position after testing procedure is completed. Failure to do so will result in improper air flow.											
Model	Motor HP	Heat Setting	Heating CFM	Heating CFM @ .50 Static				Cooling CFM @ .50 Static			
				Heat Setting A	Heat Setting B	Heat Setting C	Heat Setting D	Cool Setting A	Cool Setting B	Cool Setting C	Cool Setting D
OLFB87-E4-1A	1/2	A	1500	1500	1400	1300	1200	1400	1200	1000	800
OLFB118-E5-1A	3/4	A	1850	1850	1730	1550	1400	2000	1800	1600	1200
OLRB87-E4-1A	1/2	B	1450	1550	1450	1400	1200	1400	1200	1000	800
OLRB118-E5-1A	1	B	1730	2000	1730	1550	1450	2000	1800	1600	1200
OUIB87-E4-1A	1/2	A	1550	1550	1450	1400	1200	1400	1200	1000	800
OUIB118-E5-1A	1	B	1730	2000	1730	1550	1450	2000	1800	1600	1200

Table 3. Adjusting Airflow

Start-Up

Oil Burner

Burner Specification: Factory Settings

1. Burner type: NX
2. Air tube combination: NX70LHHS

WARNING

Do not attempt to start the burner when excess oil has accumulated in the chamber, when the furnace is full of vapor, or when the combustion chamber is very hot. Such actions could result in property damage, personal injury, or death.

CAUTION

Do not start burner unless blower access door is secured in place.

Burner Start-Up

1. Set the operating control to call for heat.
2. Open all shutoff valves in the oil supply line to burner.

3. While the ignition is on, press and release the reset button (hold 1/2 second or less). If the control has not locked out since its most recent complete heat cycle, the lockout time will be extended to 4 minutes, and the ignition will remain on for the entire heat cycle.

4. Bleed the pump until all froth and bubbles are purged. The bleed port is located on the bottom of the fuel pump. To bleed, attach a clear plastic hose over the vent plug. Loosen the plug and catch the oil in an empty container. Tighten the plug when all the air is purged.

NOTE: Bleeding might not be necessary with a two-pipe system.

5. If prime is not established within the extended lockout time, the control will lock out. Press the reset button to reset control (see Step 3).

NOTE: The reset button can be held for 15 seconds for the Beckett 7505B primary control, at any time to reset the control's lockout counter to zero and send the control to standby.

6. Repeat Steps 3 and 4, if necessary, until pump is fully primed and oil is free of bubbles. Then terminate the call for heat, and the control will resume normal operation.

Burner Adjustment

All adjustment to this furnace and its components must be done by a qualified service technician.

Refer to Table 2 for nozzle and pump pressure information.

Furnace Model	Burner Head	Nozzle/ Angle	Spray Pattern	Pump Pressure
87*	6-SLOT	.65 GPH/60	DELAVAN A	150 PSI
118	6-SLOT	.85 GPH/60	DELAVAN A	145 PSI

*Denotes low fire baffle installed. See oil burner specifications included with instructions

Table 2. Burner Information

The proper way to adjust an oil burner is with a CO₂ analyzer and a smoke gun. A properly adjusted burner will result in a quiet, clean fire which will prevent sooting and minimize cleaning. Using the following procedure will provide a margin of reserve air to accommodate variable conditions.

To adjust the burner:

1. Punch a 5/16" diameter service hole in the flue outlet. This sampling hole should be at least two flue diameters above the breech, or elbow at the breech, but ahead of the barometric damper.
2. Operate burner for approximately 5 to 10 minutes.
3. Take a draft reading at the service hole in the flue outlet. Adjust barometric draft control in the stack to achieve an overfire draft of $-.01"$ to $-.02"$ and a breach of $-.02"$ to $-.04"$.
4. Pull and record a smoke reading at the service hole using an industry standard smoke tester.
5. If the burner is producing more than #1 smoke, adjust the intake air using the zero setting locking nut and adjustment screw. Loosen the locking nut approximately one turn. Turn the adjustment screw clockwise to increase air or counterclockwise to decrease air.
6. Once the desired smoke level is achieved, use a suitable test instrument for CO₂ to take and record a CO₂ reading at the service hole in the flue outlet.
7. Adjust the air shutter (and air band, if necessary) to reduce CO₂ to the desired percentage.
8. Recheck smoke level.
9. Recheck draft and CO₂ reading at the service hole in the flue outlet.
10. Using a suitable thermometer, obtain and record the flue gas temperature at the service hole in the flue outlet.

11. Use the CO₂ reading and the flue gas temperature reading to determine unit efficiency.
12. When the proper combustion and smoke readings have been achieved, tighten the air shutter screw(s) and air band screws that were loosened in Step 5.

Nozzle and Electrode Alignment

Proper nozzle and electrode depth and alignment are essential for proper burner operation.

To check and adjust the nozzle depth:

1. Insert the small end of the "T" gauge into the end of the cone and measure from the flat of the end cone to the tip of the nozzle. The proper measurement should be 1.13". When the depth is correct, the tip of the nozzle should just touch the base of the "T" gauge.
2. Nozzle adjustments are made by sliding the entire nozzle assembly forward or backward within the blast tube.

To check nozzle alignment:

1. Insert the small end of the "T" gauge into the end of the cone and measure the nozzle and electrode alignment against the center lines marked on the gauge.
2. If nozzle is not centered, but found to be too far left or right, a new nozzle will need to be ordered. Do not attempt to adjust by bending the 90° elbow in oil line.

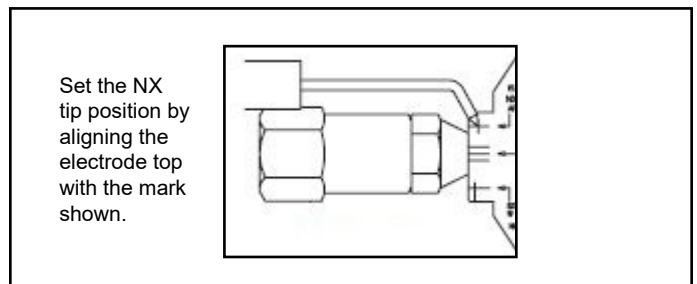

Figure 6.

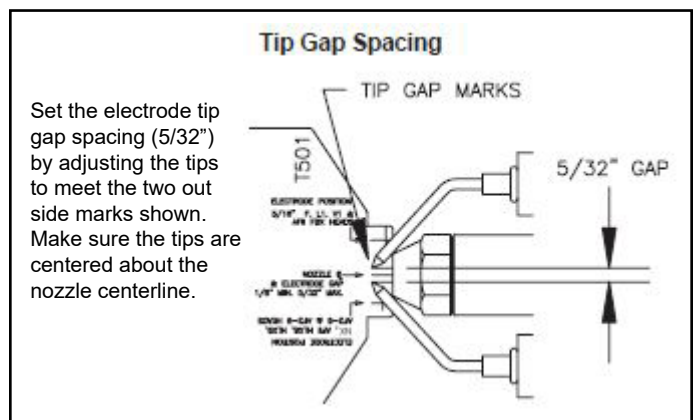

Figure 7.

Sequence of Operation

Heating

See Figure 8. The thermostat calls for heat, activating the burner motor. After a 15-second pre-purge period, power is sent to the burner and ignition is established. When the burner pump reaches full speed, the solenoid valve is energized. After the thermostat is satisfied, the thermostat circuit opens. The solenoid valve is de-energized before the pump rotation stops. Power to the burner is interrupted, shutting down the burner.

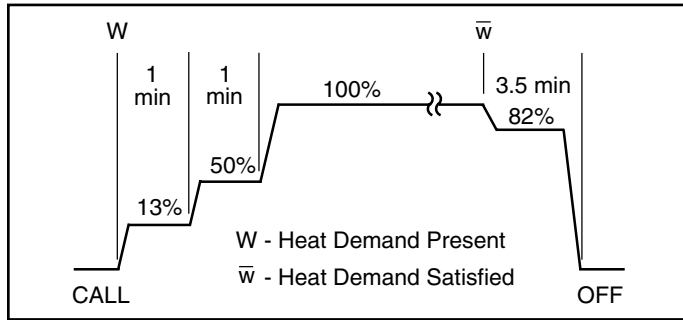

Figure 8. Heating

Cooling

Unit is set up at the factory for single stage cooling. For two stage cooling operation, the jumper wire running from Y1 to Y2 on the blower interface board must be clipped and removed. See Figure 12 for two stage cooling wiring.

If the active dehumidification feature is enabled, the circulating blower runs at 82% of the selected cooling speed as long as there is a call for dehumidification.

IMPORTANT

The system must not be in either the passive or active dehumidification mode when charging a cooling system.

Single Stage Cooling

See Figure 9. A call for cooling from the thermostat closes the R to Y circuit on the blower interface board. The control waits for a 1-second delay before energizing the circulating blower to 82% of the selected cooling CFM (passive dehumidification mode). After 7.5 minutes, the circulating blower automatically ramps up to 100% of the selected cooling airflow. When the call for cooling is satisfied, the circulating blower ramps back down to 82% of the selected cooling airflow for 1 minute, then shuts off.

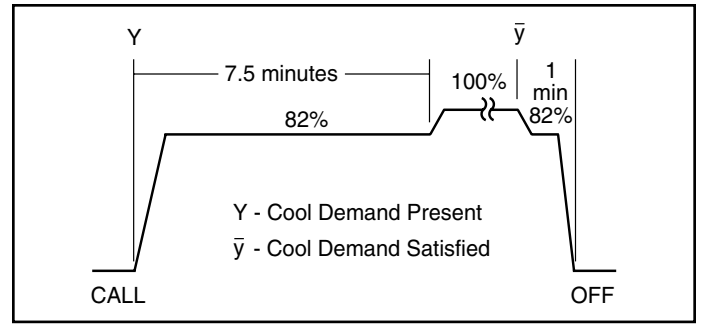

Figure 9. Single Stage Cooling

Two Stage Cooling

See Figure 10. A call for 1st stage cooling from the thermostat closes the R to Y1 circuit on the blower interface board. The control waits for a 1-second delay before energizing the circulating blower. The blower motor runs at 57% of the selected air flow for the first 7.5 minutes of the 1st stage cooling demand (passive dehumidification mode). After 7.5 minutes, the blower motor runs at 70% of the selected cooling air flow until 1st stage cooling demand is satisfied.

A call for 2nd stage cooling from the thermostat closes the R to Y2 circuit on the blower interface board. The blower motor ramps up to 100% of the selected cooling air flow. When the demand for cooling is met, the blower ramps down to Y1 until satisfied, then ramps down to 57% for 1 minute, then turns off.

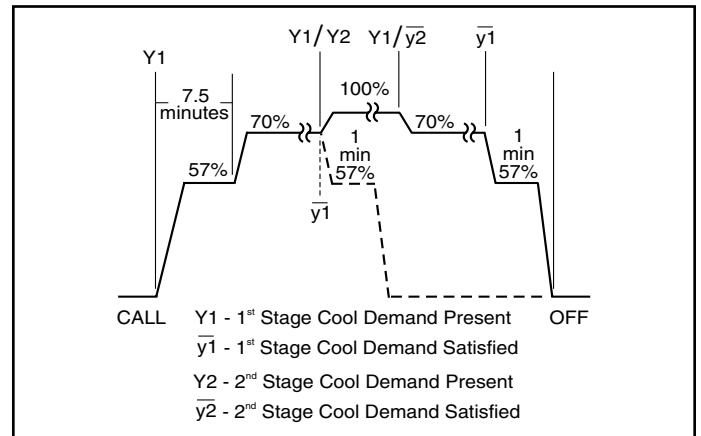

Figure 10. Two Stage Cooling

Heat Pump

For heat pump operation, clip the jumper wire between R and O. In heat pump mode, a call for heat pump operation follows the same sequence as a call for cooling with the exception that there is a 30-second blower ramp up to blower CFM.

Continuous Fan

See Figure 11. When the thermostat is set for continuous fan operation and there is no demand for heating or cooling, a call for fan closes the R to G circuit and the circulating blower motor runs at 50% of the selected cooling CFM until switched off.

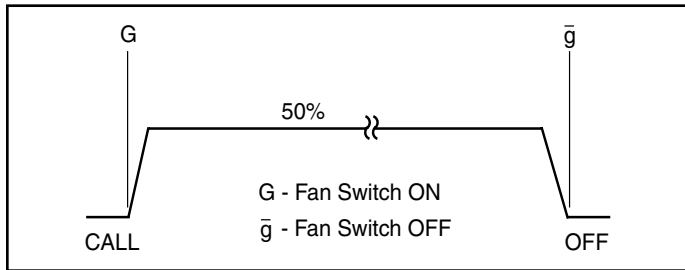

Figure 11. Continuous Fan

Maintenance and Service

Oil Burner

It is recommended that the nozzle and oil filter be checked before each heating season. Also recheck the conditions shown on the OIL FURNACE START-UP CHECKLIST found on page 2.

Close the oil line shutoff valve if the burner is shut down for an extended period of time.

Flue Pipe

Have the flue pipe inspected annually by a qualified service technician. If any soot or ash has formed inside the flue pipe, remove and clean. If the flue pipe has any holes or is rusted out, replace with a new flue pipe of the same size. Inspect the flue draft control device and replace if defective.

Blower

Blower motor is pre-lubricated and sealed for extended operation. No further lubrication is required. The blower assembly may be removed from the cabinet for cleaning and servicing of the blower. Disconnect power to the unit before servicing.

Heat Exchanger

To clean the heat exchanger:

1. Remove the vent pipe from the furnace.
2. Remove the locking screws and the caps from the two cleanout tubes; remove the flue access elbow.
3. Using a long spiral wire brush, sweep down the outer drum of the heat exchanger. Using a shop vacuum hose attachment, vacuum out all loose debris.
4. Remove the locking screw and cap from the inspection tube and with the spiral wire brush reach upward

toward the rear of the heat exchanger to clean out the crossover tube; replace the locking screw and cap on the inspection tube.

5. Do not attempt to clean the combustion chamber, as it can be easily damaged.
6. Replace the three previously removed cleanout caps and flue access elbow, making sure to re-install the locking screws.
7. Brush out and vacuum the vent outlet area of the outer drum and reattach the vent pipe.
8. Clean up around burner, blower deck, and vestibule area.

Heat exchanger cleanout kit #ABRSH380-3 is available for purchase.

Emergency Replacement Motor Operation

If the variable speed motor in this furnace needs to be replaced in an emergency situation (such as “no heat”) and an exact replacement motor is not immediately available, a standard PSC motor of equivalent frame size, voltage, rotation, and horsepower can be temporarily installed until the correct replacement motor can be obtained.

Connect the desired speed taps to the HEAT and COOL terminals and the neutral tap to the neutral terminal on the control board (refer to the furnace wiring diagram).

Verify that the unit is operating at the desired speed and within the rise range as shown on the unit rating plate. The correct replacement motor must be installed as soon as possible to ensure continued satisfactory operation of the furnace.

Emergency Fuel Pump Replacement

If replacement of the A2EA6520 fuel pump becomes necessary, replace it with another Beckett CleanCut fuel pump. In an emergency situation where the correct replacement parts are not available, an A2VA7116 fuel pump could be used. This option can produce a smoky start-up and shutdown that could result in fouling of a heat exchanger. This is only a short-term option and should be used only until the correct parts can be obtained and installed.

Complete National Fuel Gas Codes are available from:

1. **American Gas Association**
1515 Wilson Boulevard
Arlington, VA 22209
2. **National Fire Protection Association, Inc.**
1 Battery March Park
Quincy, MA 02269
3. **American National Standards Institute, Inc.**
Publications Sales Department
11 West 42nd Street
New York, NY 10036

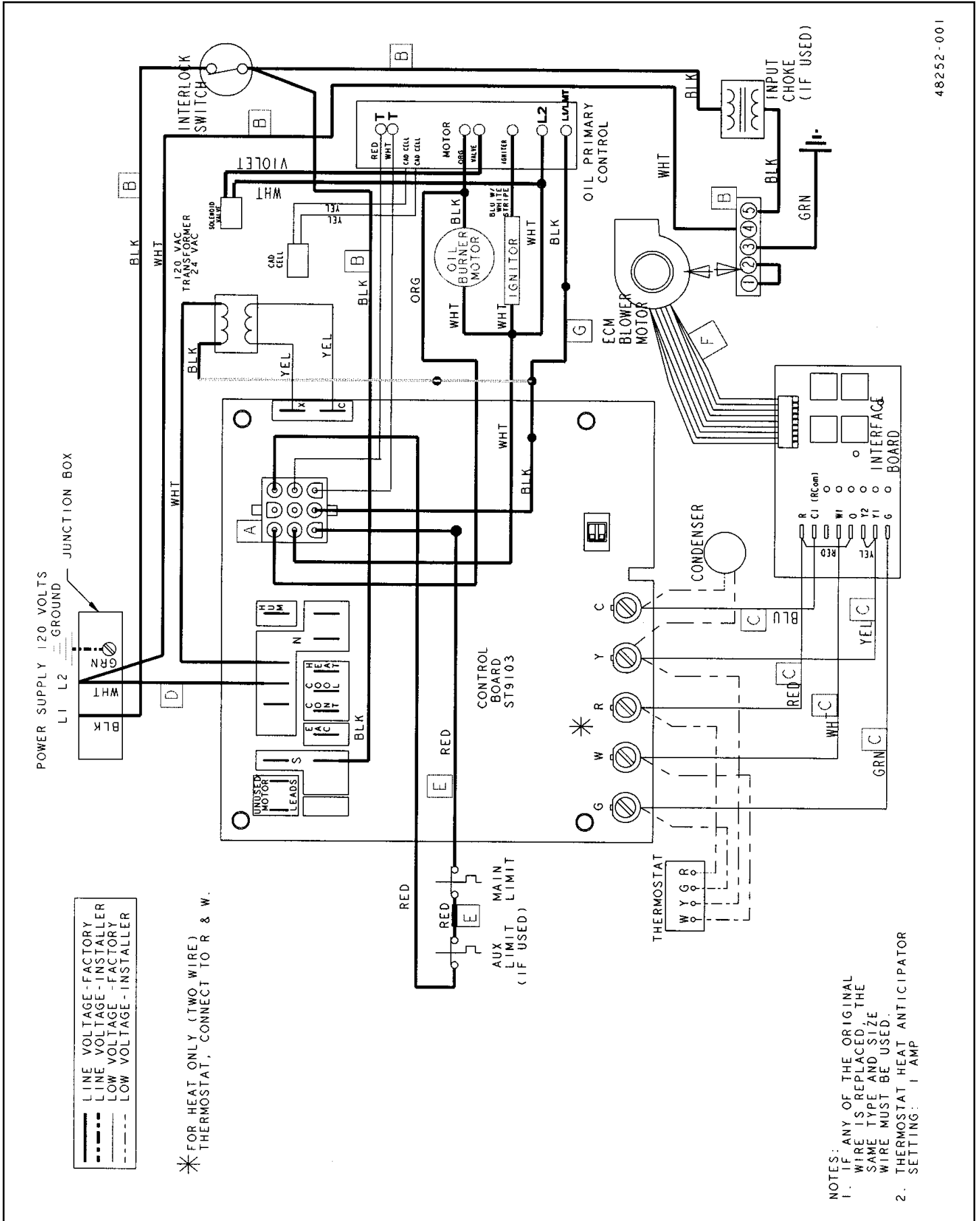

48252-001

Figure 12. Wiring Diagram
P/N 48252-001

- NOTES:
- IF ANY OF THE ORIGINAL WIRE IS REPLACED, THE SAME TYPE AND SIZE WIRE MUST BE USED.
 - THERMOSTAT HEAT ANTICIPATOR SETTING: 1 AMP