



Service & Installation



DELIVERING CONFIDENCE TO THE HVAC/R INDUSTRY FOR OVER 75 YEARS

Table of Contents

Description	Page No.
A/C Condenser Pads	.SI-4
A/C Mounting Brackets	.SI-5
A/C Whips	.SI-12
Abrasive Cloths	.SI-74
Access Fittings & Valves	.SI-40 – SI-41
Air Handler Block, Furnace	.SI-6, SI-7
Air Purifier	.SI-3
Anti-Vibration Pads	.SI-5
Batteries	.SI-68
Brazing Alloys, Solders & Fluxes	.SI-47– SI-49, SI-58
Brushes	.SI-72 – SI-74
Bulbs	.SI-31
Cable Cutter	.SI-31, SI-38
Caulking Guns	.SI-82
Chemicals	.SI-41, SI-88 – SI-92
Circuit Breaker Branch Panels	.SI-17
Circuit Breakers	.SI-16
Circuit Protection	.SI-17, SI-65
Clipboards	.SI-96
Compressor Terminal Repair Kit	.SI-50, SI-53
Concentric Vent Kits	.SI-6
Condensate Products	.SI-54, SI-64 – SI-65
Condensate Overflow Switches	.SI-54
Conduit	.SI-12
Cylinder Cradles	.SI-36
Disconnects & Safety Switches	.SI-7 –SI-11
Duct Straps, Pipe Hangers & Hooks	.SI-36 – SI-37
Electrical Fittings	.SI-33 – SI-34, SI-35
Filters	.SI-84
Filter & Heat Pump Driers	.SI-42 – SI-43
Fittings, Nylon & Galvanized	.SI-63, SI-64
Flashlights & Accessories	.SI-69
Furnace Blocks	.SI-7
Fuses JARD	.SI-25
Fuses & Power Blocks, Mersen	.SI-17 – SI-24
Fuse Pullers	.SI-75
Fuses, Zebra	.SI-26
Garden Hoses & Sprayers	.SI-93, SI-95
Gas Appliance Fittings & Valves	.SI-61
Gloves	.SI-78
Glue	.SI-88, SI-89
Hand Cleaners	.SI-79, SI-90
Hardware, Screws, Washers,Nuts, Anchors	.SI-72
Heat Pump Risers	.SI-6
Horizontal Vent Termination Kits	.SI-6
Hose Clamps	.SI-60
Knives, Repl. Blades & Sharpeners	.SI-38, SI-78

Description	Page No.
Lines & Tubing	.SI-44, SI-54
Line Set Covers	.SI-13
Maintenance Products	.SI-80, SI-86 – SI-93
Markers	.SI-88
Outlet Boxes	.SI-31 – SI-32
Plumbing & Piping Products	.SI-56 – SI-59
PVC Cement, Cleaner & Primer	.SI-56 – SI-59, SI-62 – SI-63, SI-85
PVC Fittings & Traps	.SI-63 – SI-64
Refrigerant ID Labels	.SI-71
Refrigerant Locking Caps	.SI-40
Remote Control, Universal	.SI-66
Roof Flashing & Furnace Legs	.SI-6, SI-7
Rooftop Support Systems	.SI-7
Rope	.SI-37
Rubber Straps	.SI-37
Safety Products	.SI-78
Scales	.SI-70
Sealant Products	.SI-81 – SI-85, SI-88 – SI-93
Sight Glasses	.SI-44
Solderless Terminals	.SI-50 – SI-53
Specialty Tools	.SI-49
Sprayers & Hoses	.SI-93
Spun Driers	.SI-44
Strut & Accessories	.SI-46 – SI-47
Switches & Outlets	.SI-26 – SI-27
Tape	.SI-56, SI-83 – SI-86
Tarps	.SI-36
Test Instruments	.SI-66 – SI-67
Test Leads	.SI-67
Textbooks	.SI-96
Thermometers	.SI-70 – SI-71
Thermostat Guards	.SI-14 - SI-15
Thermostat Wire	.SI-30
Tool boxes & Bags	.SI-94 – SI-95
Tools, Hand	.SI-45, SI-74 – SI-78
Towels	.SI-80
Tubing Tools	.SI-44 – SI-45
Vibration absorbers, Stainless Steel	.SI-45
Wire Caddy	.SI-31
Wire Markers	.SI-31
Wire Nuts	.SI-28
Wire Products	.SI-29 – SI-30
Wire Ties	.SI-38
Wiring Devices	.SI-26 – SI-27, SI-35 – SI-36
Water Leak Alarms	.SI-55
Water Saber Pro	.SI-93

Whole Home Air Purifier



Made in USA With Globally Sourced Components

Comfort-Aire® Whole Home In-Duct Air Purification System

Reduces 99.9% Of Harmful Airborne Microbials

The Comfort-Aire in-duct whole home air purifier reduces mold, VOCs, viruses, bacteria, tobacco smoke, and common household odors using photocatalytic oxidation (PCO). Two UV-C sources (gas lamp and LED) react with two proprietary substrates to create a large field of oxidizing agents within the duct. As contaminants in the air pass through the field, the oxidizing agents attack and break down the microbials resulting in cleaner, healthier, and fresher smelling air. This unit is certified zero ozone.

Features:

- For Use In Air Handlers Up To 2000 CFM
- All Hardware Included For Simple In-Duct Installation
- Digital Countdown Timer For Visual Indication Of UV-C Lamp Replacement
- Operates Continuously For Extended Lamp Life (3+ Years)
- Limited Warranty:
 - 7 Years Unit
 - 3 Years UV-C Gas Lamp

Specifications:

- cETLus Listed : CE Certified
- Conforms To UL 1598:2021 Ed. 5
- Conforms To CSA C22.2#250.0:2021 Ed. 5
- Certified Zero Ozone
- Approved For Sale In California
- Power Consumption:
 - 120VAC .22A 26W
 - 208VAC .13A 26W
 - 240VAC .11A 26W

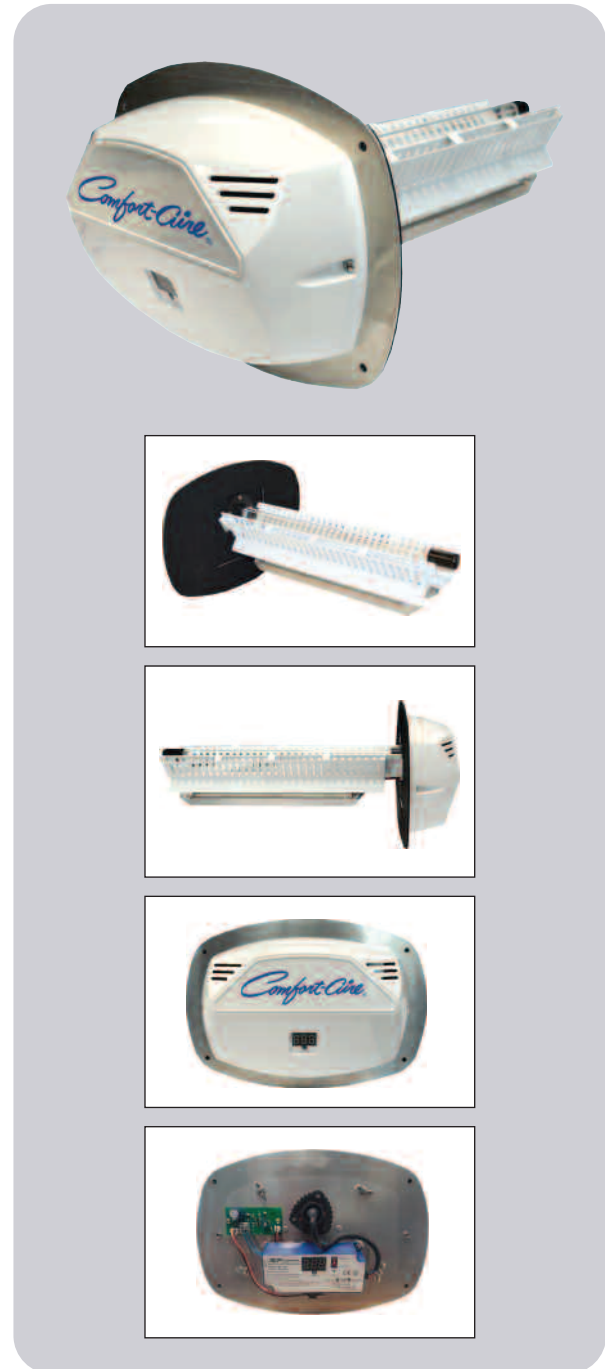

MARS NO.	DESCRIPTION	VOLTAGE
00700	Whole Home Air Purifier	120, 208-240
00701	Replacement UV-C Lamp	-
00702	Replacement UV-C LED Cell	-

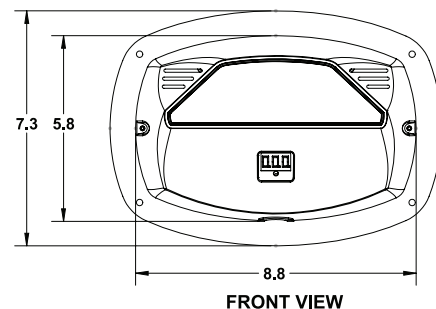
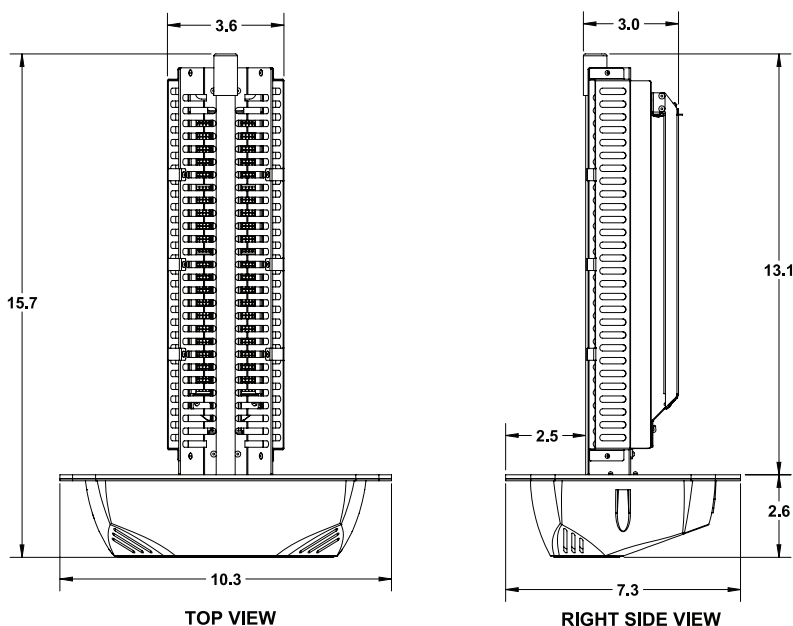

Accessories

MARS Condenser Pads

MARS is pleased to offer a full line of Air Conditioning Condenser Pads. These dark gray plastic pads are molded from polypropylene. The lightweight, one piece constructed pads are virtually unbreakable and built to last. Two and three inch thick pads are available.

Features & Benefits:

- UV stable – prevents weathering or cracking
- Chemical resistant
- Solid wall construction
- Will not chip or crack
- Lightweight
- Textured surface – prevents unit from sliding
- Unique footpads – prevent unit from sinking into ground
- Size molded in side of pad
- Drillable for attachment of unit

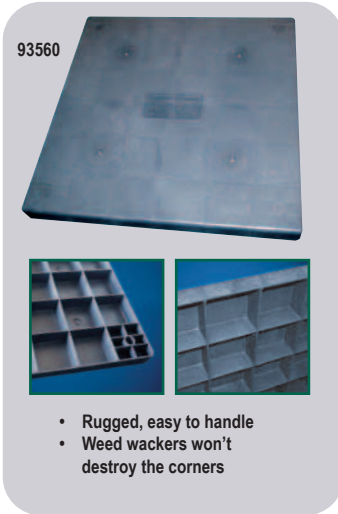

- Rugged, easy to handle
- Weed wackers won't destroy the corners

MARS NO.	DESCRIPTION	PALLET QTY.
93560	24" x 24" x 2"	22
93577	24" x 24" x 3"	16
93561	24" x 36" x 2"	22
93562	32" x 32" x 2"	22
93587	32" x 32" x 3"	16
93573	36" x 36" x 2"	22
93592	36" x 36" x 3"	16
93576	36" x 40" x 2"	22
93593	36" x 40" x 3"	16
93594	36" x 48" x 3"	16
93595	40" x 40" x 3"	16

MARS Stackable Condenser Pads

MARS Stackable A/C condenser pads are high impact 100% recycled composite plastic which makes them lightweight, sturdy and very durable. These pads are a must have for any unit. They are UV Stable and chemical resistant eliminating weathering and cracking over time. The textured surface prevents the unit from sliding and is drillable for attachment of any unit.

You will discover for yourself that these may just be the last equipment pad you will ever choose.

Features:

- Nesting design
- High impact 100% recycled composite



When stacked, three 3" pads are 5.1" tall

MARS NO.	SIZE (INCHES)	WEIGHT RATING * (MAX.)	PADS PER PALLET
89540	18 x 38 x 3	2,200 Lbs	38
89577	24 x 24 x 3	2,200 Lbs	45
89565	30 x 30 x 2	2,200 Lbs	45
89584	30 x 30 x 3	2,200 Lbs	38
89562	32 x 32 x 2	2,200 Lbs	45
89587	32 x 32 x 3	1,980 Lbs	38
89573	36 x 36 x 2	1,650 Lbs	45
89592	36 x 36 x 3	1,540 Lbs	38
89593	36 x 40 x 3	1,540 Lbs	38
89595	40 x 40 x 3	1,320 Lbs	38

* Rating based on 5mm deflection with weight applied evenly across surface.

MARS A/C Mounting Brackets

Heavy duty engineered steel A/C brackets are used for mounting A/C condensers and heat pumps on vertical walls. Brackets include mounting holes and are finished in a durable gray powder coat.

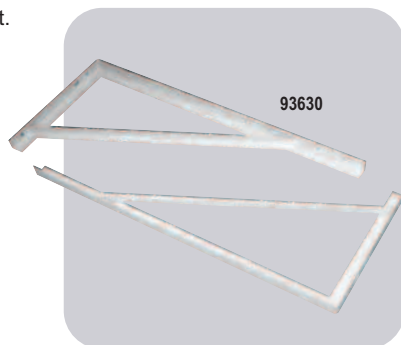

MARS NO.	DESCRIPTION	MARS PACK
93630	30" Powder Coated Steel Bracket	1 Pair
93631	36" Powder Coated Steel Bracket	1 Pair
93632	42" Powder Coated Steel Bracket	1 Pair
93636	48" Powder Coated Steel Bracket	1 Pair

* Max load Capacity up to 500 lbs. Wall load limitations is restricted by strength of hardware used

MARS Universal Mini-Split Condenser Wall Mount Brackets

MARS mini-split brackets are available in four sizes to accommodate mounting of popular mini-split compressors.

Bracket kits include mounting hardware and vibration absorbers for a professional installation. Pre-assembled vertical supports speed installation.



- Powder Coat Finish - resists rust and corrosion
- Mounting and attachment hardware included
- Bracket width and depth adjust to accommodate compressor size
- Vibration pads included for a durable and quiet installation
- Pre-assembled vertical supports reduce installation time

MARS NO.	SIZE H X L X W	LOAD CAPACITY (LBS)
93640	14.5" x 18" x 33.5"	260
93641	18" x 22" x 33.5"	330
93642	18" x 24" x 33.5"	400

* Max load Capacity up to 500 lbs. Wall load limitations is restricted by strength of hardware used

Anti-Vibration Pads

MARS offers a complete line of anti-vibration pads. These high quality rubber pads provide maximum loading of 60 lbs. per square inch. Anti-vibration pads can be used on any type of mechanical/electrical machines such as pumps, motors, air conditioning units, generators, compressors, etc. The plain rubber pads have grooves on both sides. The cork rubber pads are the same but with the added advantage of reduction in sound level. The natural rubber Iso-Pads can be easily cut for odd sized dimensions under equipment legs and supports. The use of these pads eliminates the need for bolting down equipment to the floor. These Iso-Pads provide superior isolation, attenuation and vibration characteristics.

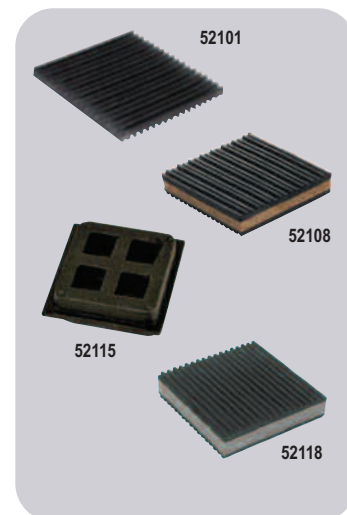

MARS NO.	DESCRIPTION	MARS PACK
52101	2" x 2" x 3/8" Rubber	1
52103	4" x 4" x 3/8" Rubber	1
52104	6" x 6" x 3/8" Rubber	1
52107	18" x 18" x 3/8" Rubber	1
52108	2" x 2" x 7/8" Cork/Rubber	1
52109	3" x 3" x 7/8" Cork/Rubber	1
52110	4" X 4" X 7/8" Cork/Rubber	1
52111	6" x 6" x 7/8" Cork/Rubber	1
52114	18" x 18" x 7/8" Cork/Rubber	1
52115	2" x 2" x 3/4" Iso-Pad	1
52116	4" x 4" x 3/4" Iso-Pad	1
52117	18" x 18" x 3/4" Iso-Pad	1
52119	2" x 2" x 7/8" Foam/Rubber	1
52118	4" x 4" x 7/8" Foam/Rubber	1
52120	6" x 6" x 7/8" Foam/Rubber	1
52122	18"x18"x7/8" Foam/Rubber	1

Accessories

MARS Heat Pump Risers

Heavy duty composite heat pump risers are available in 2 popular heights in a cost effective 1 piece design as well as a 2 piece terrain adaptable design. Each riser includes factory installed buyt/mastic patches on the top and bottom to absorb vibration and reduce noise.



MARS NO.	DESCRIPTION	MARS PACK
93600	3" 1 Piece Heat Pump Riser	48
93602	3" 2 Piece Heat Pump Riser	32
93601	6" 1 Piece Heat Pump Riser	24
93603	6" 2 Piece Heat Pump Riser	16
93604	4" Riser Extension	16
93639	Adjustable 5-3/4" to 7" Heat Pump Riser	16

Roof Flashings

Galvanized no calk® roof flashings feature a one-piece construction which insures a positive leak proof installation every time. Specially formulated elastomeric collar allows the vent stack plenty of room for expansion and contraction. The patented double seal no-calk collar "gives" with the pipe, without breaking the water tight seal. The galvanized base is made from 24 gauge deep drawing steel extra high with no seams.

Flex Flash flashings are manufactured from a special formulated elastomer material which is extremely flexible and durable. They permit the vent stack to expand and contract freely without disrupting the seal between pipe and flashing collar. The flashing adjusts to most any angle and adapts to all type of pipe; copper, cast iron, galvanized or plastic. Fits up to 40° angle.



MARS NO.	DESCRIPTION	MARS PACK
79360	1 1/4" - 1 1/2" no calk galvanized, 9" x 12.5" base	12
79361	2" no calk galvanized, 9" x 12.5" base	12
79362	3" no calk galvanized, 11" x 14.5" base	12
79364	1/2", 3/4", 1" no calk galvanized solar, 9" x 12.5" base	12

MARS Concentric Vent Kits

MARS Concentric Vent Kits provide a single wall or roof penetration solution for high efficiency gas furnaces. Concentric vents save time and money by streamlining installation compared to the traditional 2 pipe system. Concentric vents also improve the aesthetics of the home by reducing the number of wall and roof penetrations. All necessary fittings are included in the kit. (The installing contractor needs to supply pipe and fittings between the furnace and concentric vent)

Features

- UL Approved
- Available in 2" and 3" kits
- Single Wall / Roof penetration
- White PVC



MARS NO.	DESCRIPTION	MARS PACK
72950	2" Concentric Vent Kit	6
72951	3" Concentric Vent Kit	4
72956	2" Repl Cap for 72950	1
72957	3" Repl Cap for 72951	1

MARS Horizontal Vent Termination Kits

MARS Horizontal Vent Termination Kits are designed for use with high efficiency condensing gas furnaces. The kit provides a low profile means of terminating exterior PVC intake and exhaust wall penetrations.

Features:

- Low profile design
- Hides vent pipes for a clean and finished look
- Designed for use with high efficiency gas furnaces
- Kit includes mounting hardware



MARS NO.	DESCRIPTION
72952	2" Horizontal Vent Termination Kit
72953	3" Horizontal Vent Termination Kit

MARS Air Handler Blocks

- Lightweight 2 lb styrofoam block
- 8" x 8" x 4"

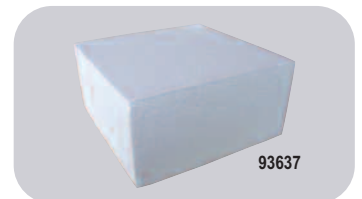

MARS NO.	DESCRIPTION
93637	8" x 8" x 4" Air Handler Block, Pkgd in boxes of 20 (21 boxes per pallet)

MARS Easy Leveler™ Furnace Legs

- Includes 4 easy leveler legs & sheet metal screws
- Designed to level a furnace & air conditioning coil for proper drainage.
- Proper leveling helps eliminate standing water, thus reducing bacteria
- Easily adjustable even after installation
- Legs can support up to 400 lbs.
- Adjustable from 2-3/4" to 4" in height



MARS NO.	DESCRIPTION	MARS PACK
79095	Adjustable furnace legs	12

Economy Furnace Mounting Blocks

- Holds furnace 2" off the floor
- Absorbs vibration, reduces noise
- Composite construction
- Peel & stick installation



MARS NO.	DESCRIPTION	MARS PACK
79085	Economy furnace mounting blocks	12

Rooftop Support Systems

Economy CX-Series

- Base only
- Material – 100% recycled rubber, UV resistant

CX Series rooftop support is designed as an economic alternative when a high load bearing is not required. They are perfect for supporting conduit or smaller pipe.

C-Series

- Material – 100% recycled rubber, UV resistant
- C Series channel support is designed for superior support of gas and refrigeration piping systems, cable tray, electrical conduit multiple lines, HVAC equipment and many other applications.

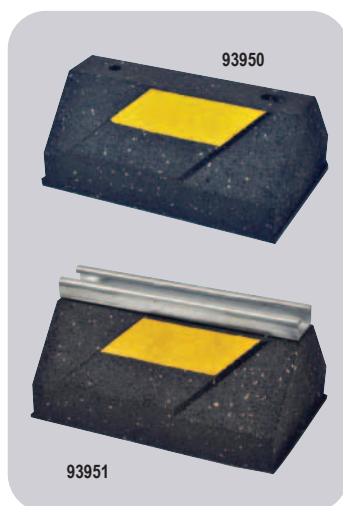

MARS NO.	DESCRIPTION	MARS PACK	CASE QTY.	MAX. LOAD
93950	CX-Series 4" H x 6" W x 9.6" L	1	240	500 lbs./ft.
93951	C-Series 4 7/8" H x 6" W x 9.6" L	1	200	700 lbs./ft.

MARS Front Open Pullout Disconnect Boxes - NEMA 3R

MARS offers both fusible and non-fusible single phase air conditioner disconnects. These units provide a disconnecting means which should be located within sight from and readily accessible from the air conditioning or refrigerating equipment. UL listed. MARS #83315 is also CUL listed



MARS NO.	DESCRIPTION	STD. PACK	CASE QTY.
83315	60 amp non-fused, single phase	6	6
83316	30 amp fused, single phase	6	6
83317	60 amp fused, single phase	6	6
83396	Compact 30 amp fused, single phase	6	6
83335	Generic brand 60 amp non-fused, single	6	6

MARS Side Open Pullout Disconnect Boxes - NEMA 3R

The MARS Side Open Disconnect Boxes are contractor friendly and feature a unique side opening door, allowing easy access to the work area. The powder coated UV rated finish provides superior esthetics and greater longevity. The patented "finger safe" pullout section prevents accidental contact with electrodes. Easy to remove knockouts and a secure locking mechanism are also featured. This Pullout Disconnect Box is the ideal choice for the busy contractor.

MARS 80328 features an on/off switch so there are no pullout handles to be lost.

Specifications:

- Single phase, 240V
- 10,000 amp rated
- NEMA 3R, rainproof
- UL & CUL rated



MARS NO.	DESCRIPTION	STD. PACK	CASE QTY.
80315	60 amp non-fused	6	6
80316	30 amp fused	6	6
80317	60 amp fused	6	6
80328	60 amp non-fused – Switch Disconnect	6	6

Accessories

MARS Low Profile 60A Non-Fused Disconnect

MARS side open low profile disconnect box is compact while providing easy access to the connection points. The finger safe pullout section prevents accidental contact with the live circuit. The lugs are rated for multi-conductors and are approved for use with surge protection devices.

Specifications:

- Single phase, 120/240V
- Dimensions: 6.625 x 5 x 2.50
- Tin plated copper pullout
- Lugs rated for multi-conductors
- 10,000 Amp max. rated
- NEMA 3R, rainproof
- cULus rated



MARS NO.	DESCRIPTION	STD. PACK	CASE QTY.
80301	60 amp non-fused	10	10

Midwest A/C Disconnects - NEMA 3R



Midwest Fusible disconnects are available in 30 and 60 Amp models. Pullers are removable or reinstallable in the OFF position for the user safety during equipment maintenance.

Specifications:

- 30-100 Amps
- 120/240V AC, Single Phase
- Accepts class H fuses (not included)



MARS NO.	DESCRIPTION	STD. PACK	CASE QTY.
83385	60 amp non-fused, single phase	6	6
83386	30 amp fused, single phase	6	6
83387	60 amp fused, single phase	6	6

Pullouts For MARS Disconnect Boxes

MARS offers both fusible and non-fusible single phase non-metallic air conditioner disconnects. These horse power rated units are constructed of Noryl® thermoplastic for extended and



MARS NO.	DESCRIPTION	CASE QTY.
83313	60 amp non-fused pullout for 83315	1
83314	30 amp fused pullout for 83316	1
83319	30 amp fused pullout for 83396	1
80312	60 amp non-fused pullout for 80315 & 80308	1
80313	30 amp fused pullout for 80316	1
80314	60 amp fused pullout for 80317	1

MARS A/C Disconnect/GFCI Receptacle Combination

MARS A/C Disconnect/ GFCI Receptacle Combination disconnects provide a convenient low cost means to satisfy NEC Article 210.63 requirements for HVAC/R Equipment Outlets and Article 406.8(B)(1) for Receptacle – Wet Locations. The NEMA 3R design insures a safe, weather tight installation for residential, light commercial and even some industrial applications.

Features & Benefits:

- 60 amp, non-fused, pullout type
- 240 volt A/C, single phase
- UL & CUL listed
- Compact size – 5"x7"x4"
- Meets NEC #210.63 & #406.8(B) (1)
- Removable cover
- Heavy galvanized 'G90' steel with highest quality electro-deposition finish resists corrosion and fading
- NEMA 3R rated



MARS NO.	DESCRIPTION	STD. PACK	CASE QTY.
83308	60 Amp, Non-Fused, 15 Amp, 125V GFCI Duplex Receptacle	6	6
83309	60 Amp, Non-Fused, 20 Amp, 125V GFCI Duplex Receptacle	6	6

MARS Side Open Pullout Disconnect w/GFCI Receptacle

The MARS Side Open Disconnect w/GFCI Receptacle provides a convenient low cost means to satisfy NEC 2003 code changes requiring that a GFCI receptacle with a "while in use" cover be within a 25ft line of sight of the condenser unit. The pre-wired receptacle with stripped wire ends makes installation of disconnect and receptacle quick and easy. This unit provides a significantly lower "installed cost" to the contractor when compared to installing a standard disconnect and separate GFCI receptacle with "while in use" cover to comply with the new NEC code change.

Additional features and benefits include: Convenient electrical power cord channel w/retaining clip for easy and safe use of portable tools; Large wiring compartment for both disconnect switch and receptacle; Angled receptacle mounting to eliminate the possibility of crushing portable electrical plugs when closing "while in use" cover; Attractive side opening cover design for ease of installation; Ultra UV powder coating.

Specifications:

- 60 amp, non-fused, pullout type
- Pre-wired 15A, 125V GFCI receptacle included
- 240 volt, single phase
- 10,000 amp rated
- NEMA 3R & UL rainproof
- UL & CUL approved
- Rated for 10HP @ 240 volts
- Meets NEC #210.63 & #406.8(B)(1)
- Multiple patents pending

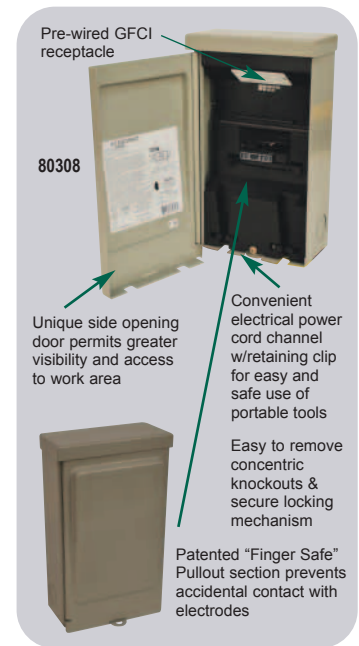

MARS NO.	DESCRIPTION	STD. PACK	CASE QTY.
80308	Pullout disconnect, W/GFCI receptacle	6	6

Midwest A/C Disconnect/GFCI

Midwest Top Open A/C Disconnect, 120/240 VAC, 60 A, 3 to 10 hp, 1 Phase, 20 Amp GFCI, NEMA 3R



MARS NO.	DESCRIPTION	STD. PACK	CASE QTY.
83345	30 Amp Fused, 20A GFCI Receptacle	6	6
83395	60 Amp Fused, 20A GFCI Receptacle	6	6

Midwest Non-Metallic Disconnects - NEMA 3R

Midwest Electric offers both fusible and non-fusible single phase non-metallic air conditioner disconnects. These horse power rated units are constructed of Noryl® thermoplastic for extended and rugged durability. Units are corrosion resistant, weatherproof, and maintenance free. UL listed and CSA certified.



MARS NO.	DESCRIPTION	STD. PACK	CASE QTY.
83312	60 amp non-fused, single phase	6	6
83306	30 amp fused, single phase	6	6
83307	60 amp fused, single phase	6	6

Midwest Three Phase Pullout Disconnects - 240V - NEMA 3R

Midwest Electric three phase pull out disconnects and single phase non-automatic switches are manufactured of heavy zinc coated steel with highest quality electro-deposition paint finish for maximum corrosion resistance. The three phase disconnects are available with and without fuse protection. Fusible units require three fuses. NEMA 3R.



MARS NO.	DESCRIPTION	CASE QTY.
83321	60 amp non-fused, three phase	4
83322	30 amp fused, three phase	4
83323	60 amp fused, three phase	4

Midwest Non-Automatic Disconnects - Nema 3R

Midwest Electric has developed a new NEMA 3R, non-automatic A/C disconnect with a patent pending on/off switch mechanism so there is no pullout to lose. This UL and CSA listed disconnect features: a keyhole mounting slot for easy installation, a removable door for easy wiring access, straight in and out lugs for quick connections and six 1/2" x 3/4" x 1" concentric knockouts.

The single phase non-automatic disconnects do not provide overcurrent protection with manual internal on/off switch



MARS NO.	DESCRIPTION	STD. PACK	CASE QTY.
83328	60 amp, 240V, 10 HP	6	6

Midwest Heat Pump Disconnects - NEMA 3R

Multiple disconnect devices are offered for heat pump applications that require individual disconnects for the heating and cooling cycles. The dual pull outs accommodate either a 30A/60A or 60A/60A puller combination. Units require four fuses.

- Specifications:**
- 120/240 AC



MARS NO.	DESCRIPTION	CASE QTY.
83324	90 amp fused	1
83325	100 amp fused	1

Midwest Evaporative Cooler Disconnects - NEMA 3R

Evaporative cooler applications not only require fusing but switching or receptacle functions depending on equipment type and local codes. The 40 ampere unit utilizes 3 S plug fuses.



MARS NO.	DESCRIPTION	CASE QTY.
83327	40 amp fused, receptacles	1

Accessories

Midwest Non-Metallic, Non-Auto Switch Residential/Construction A/C Disconnect, NEMA 3R



MARS NO.	DESCRIPTION	STD. PACK	CASE QTY.
83388	60 amp non-fused, single phase	6	6

Midwest Metallic Residential/Construction, A/C Disconnects w/ Receptacle, NEMA 3R



MARS NO.	DESCRIPTION	STD. PACK	CASE QTY.
83398	60 amp non-fused, single phase	6	6

I-T-E Cartridge Fuse Type - UL Listed

1 Phase/2 wire, 3 Phase/3 wire, solid neutral



MARS NO.	DESCRIPTION	TYPE	CASE QTY.
83330	30a - 240V 2 pole, exterior	3R	10
83331	60a - 240V 2 pole, exterior	3R	5
83336	30a - 240V 3 pole, exterior	3R	10
83337	60a - 240V 3 pole, exterior	3R	5
83339	30a - 240V 3 pole, interior	1	1
83340	60a - 240V 3 pole, interior	1	1

I-T-E Plug Fuse Type - UL Listed

1 Phase, solid neutral

MARS NO.	DESCRIPTION	TYPE	STD. PACK	CASE QTY.
83342	30a - 120V 1 pole, interior	1	6	6

I-T-E General Duty Enclosed Switches



Non-Fused

MARS NO.	DESCRIPTION	TYPE	CASE QTY.
83346	30a - 240V 2 or 3 pole, 3 phase exterior	3R	5
83347	60a - 240V 2 or 3 pole, 3 phase, exterior	3R	1
83349	30a - 240V 2 or 3 pole, 3 phase interior	1	1
83350	60a - 240V 2 or 3 pole, 3 phase interior	1	1
83352	60a - 240V 1 or 2 pole, 1 phase exterior	3R	10

Fused

MARS NO.	DESCRIPTION	TYPE	CASE QTY.
83636	30a - 240V, 3 Pole, 3 Phase, exterior	3R	1
83637	60A - 240V, 3 Pole, 3 Phase, exterior	3R	1

I-T-E Heavy Duty 3PH 600V - Type 1 - Indoor



MARS NO.	DESCRIPTION	CASE QTY.
83353	30a - 600V fused	1
83354	60a - 600V fused	1

I-T-E Heavy Duty 3PH 600V - Type 3R - Outdoor



MARS NO.	DESCRIPTION	CASE QTY
83359	30a - 600V fused	1
83360	60a - 600V fused	1
83361	100a - 600V fused	1
83362	30a - 600V unfused	1
83363	60a - 600V unfused	1
83364	100a, 600V-3P non-fused	1

Midwest HD 3P Disconnects – NEMA 3R - Outdoor



Midwest heavy duty disconnects are designed for commercial and industrial applications where safety, high performance and continuity of service are essential.

Features:

- Quick-make, Quick-break mechanism
- Highly visible red handle grip, Designed for hook stick operation
- Meets or exceeds NEMA KS1 standard for enclosed switches – Type HD
- Full cover interlocks

Specifications:

- 3 Wire, 3 Pole
- 600 VAC
- 60/75°C conductor rating
- Enclosure type: Nema 3R (outdoor)
- cUL certified and UL listed



MARS NO.	DESCRIPTION	CASE QTY.
83383	30A, 600V-3P, Fused	1
83384	60A, 600V-3P Fused	1
83389	100A, 600V-3P, Fused	1
83390	200A, 250V-3P, Fused	1
83392	200A, 600V-3P, Fused	1
83393	200A, 600V-3P, Non-Fused	1

Midwest Fused Disconnect - NEMA 3R



Midwest Electric offers a general duty switches designed for residential and light commercial applications where duty is not severe.

Features:

- Highly visible red handle grip, Designed for hook stick operation
- Quick-make, quick-break mechanism
- 60/75°C conductor rating

Specifications:

- General Duty, NEMA 3R, Outdoor
- 240VAC
- cULus



MARS NO.	DESCRIPTION	CASE QTY.
83329	100A, 240V-3P, Fused, 4 Wire	1
83391	200A, 250V-3P, Non-Fused, 3 Wire	1

Top Open A/C Disconnects, NEMA 3R

MARS offers both fusible and non-fusible single phase air conditioner disconnects. These units provide a disconnecting means which should be located within sight and readily accessible from the air conditioning or refrigerating equipment.

- Single phase
- 120/240 Volts
- Fused Disconnects - accepts type H fuse (not included)
- 10kAIC
- Enclosure material: galvanized steel
- NEMA 3R, rainproof, outdoor use
- Dimensions: 9.21" H x 5.45" W x 3.13" D



MARS NO.	DESCRIPTION	STD. PACK	CASE QTY.
83615	60 Amp, Non-Fused	6	6
83616	30 Amp, Fused	6	6
83617	60 Amp, Fused	6	6

Ground Lug Kit

Siemens low voltage VB heavy duty safety switch accessory. Ground lug kit rated 600V, suitable for operating currents 30/60/100/200A.



MARS NO.	DESCRIPTION
83303	HD Safety Switch kit

Accessories

MARS A/C Whips Non-Metallic Fittings

Non-metallic conduit with non-metal fittings. Assembled with UL approved components.

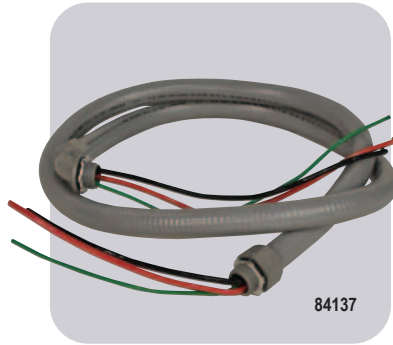

MARS NO.	DESCRIPTION	MARS PACK
84131	4' x 1/2" #10 ga. non-metallic whip UL	1
84133	4' x 3/4" #8 ga. non-metallic whip UL	1
84135	6' x 1/2" #10 ga. non-metallic whip UL	1
84137	6' x 3/4" #8 ga. non-metallic whip UL	1
84139	8' x 1/2" #10 ga. non-metallic whip	1
84141	8' x 3/4" #8 ga. non-metallic whip	1
84143	10' x 3/4" #8 ga. non-metallic whip	1

MARS Bulk Packaged A/C Whips, Non-Metallic Fittings

Non-metallic conduit with non-metallic fittings. These are individually packaged. Assembled with UL approved components.

- Packaged gaylord style
- Bulk box for easy access



MARS NO.	DESCRIPTION	MARS PACK
84181	4' x 1/2" #10 ga. non-metallic whip UL	90
84183	4' x 3/4" #8 ga. non-metallic whip UL	60
84185	6' x 1/2" #10 ga. non-metallic whip UL	60
84187	6' x 3/4" #8 ga. non-metallic whip UL	45

MARS A/C Whips Metallic Fittings

Non-metallic conduit with metal fittings. Assembled with UL approved components.

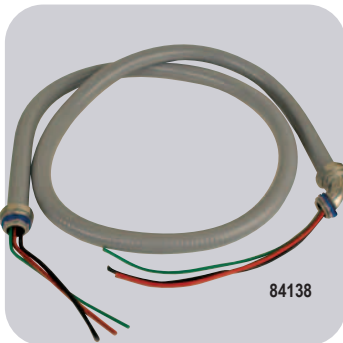

MARS NO.	DESCRIPTION	MARS PACK
84132	4' x 1/2" #10 ga. metallic whip UL	1
84134	4' x 3/4" #8 ga. metallic whip UL	1
84136	6' x 1/2" #10 ga. metallic whip UL	1
84138	6' x 3/4" #8 ga. metallic whip UL	1

All Whips Bagged

MARS A/C Whips All Metallic

MARS NO.	DESCRIPTION	MARS PACK
84125	4' x 1/2" all metallic whip	1
84126	4' x 3/4" all metallic whip	1
84127	6' x 1/2" all metallic whip	1
84128	6' x 3/4" all metallic whip	1

Sealtite® Flexible Metallic Conduit

Sealtite® flexible conduit provides protection for wet or oily locations. UL listed conduit has a continuous copper ground built into the core. All UL listed Sealtite® is UV resistant.



MARS NO.	DESCRIPTION	MARS PACK
84102	1/2", metallic conduit, UL, boxed 100 ft	1
84103	3/4", metallic conduit, UL, boxed 100 ft	1
84110	1/2", metallic conduit, boxed 100 ft	1
84111	3/4", metallic conduit, boxed 100 ft	1

Liquid-Tight Flexible Non-Metallic Conduit

- Flexible PVC construction. Phthalate free.
- Lightweight and lower installed cost
- Oil/water resistant
- Sunlight resistant, direct burial
- Crush resistant
- Temperature rated: -18°C to 75°C
- UL listed, CSA certified



MARS NO.	DESCRIPTION	MARS PACK
84118	1/2", non-metallic conduit, UL, boxed 100 ft	1
84119	3/4", non-metallic conduit, UL, boxed 100 ft	1
84120	1", non-metallic conduit, UL, boxed 100 ft	1
84121	1/2", non-metallic conduit, UL, polybag 25 ft	1
84122	3/4", non-metallic conduit, UL, polybag 25 ft	1

Line Set Covers

Attractive and durable line set cover for protecting and concealing refrigerant tubing/insulation, control wire, and drains. Ideal for ductless and all other applications requiring exposed refrigeration line sets. All connectors have front and back plates which fasten together with two screws.

- Vulnerable components are protected from solar/environmental exposure
- Aesthetically conceals mechanicals in architectural-grade, paintable plastic duct
- Two (2) separate cover sizes to choose from – 3" and 4" duct widths – provide ample room for multiple line sets and larger tonnage equipment
- Easy, flexible configuration for new or retrofit applications

MARS NO.	DESCRIPTION	COLOR	DIMENSIONS (INCHES)					CASE QTY.
			A	B	C	D	E	
93728	Line Set Cover Kit, 3 in.	White	-	-	-	-	-	1
93729	3.25 Foot Straight Duct, 3in.	White	3.1	2.4	39.4	-	-	8
93730	Wall Cover, 3 in.	White	1.2	2.6	3.3	5.5	4.3	5
93731	90 Degree Wall Corner, 3 in.	White	3.1	3.3	4.3	8.3	-	10
93732	90 Degree Corner, 3 in.	White	3.3	2.7	3.9	-	-	5
93733	Plane Corner, 3 in.	White	3.4	2.8	4.5	-	-	10
93734	Duct Connector, 3 in.	White	3.5	2.7	2.0	-	-	10
93735	End Cap, 3 in.	White	3.3	2.7	3.8	2.3	1.9	5
93736	Flexible Duct, 3 in.	White	23.6	2.5	2.9	-	-	10
93737	Line Set Cover Kit, 4 in.	White	-	-	-	-	-	1
93738	3.25 Foot Straight Duct, 4 in.	White	3.9	2.8	39.4	-	-	6
93739	Wall Cover, 4 in.	White	1.5	2.7	4.3	5.1	5.7	5
93740	90 Degree Wall Corner, 4 in.	White	4.1	3.3	5.3	8.4	-	5
93741	90 Degree Corner, 4 in.	White	4.3	2.9	4.6	-	-	5
93742	Plane Corner, 4 in.	White	4.3	2.9	5.4	-	-	5
93743	Duct Connector, 4 in.	White	4.3	2.9	2.0	-	-	5
93744	Flexible Duct, 4 in.	White	28.3	2.5	3.6	-	-	5

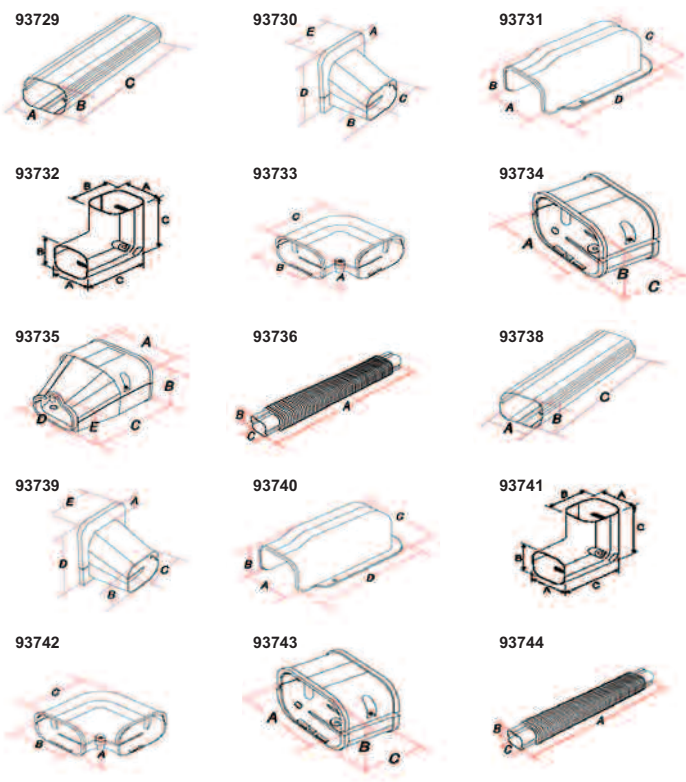
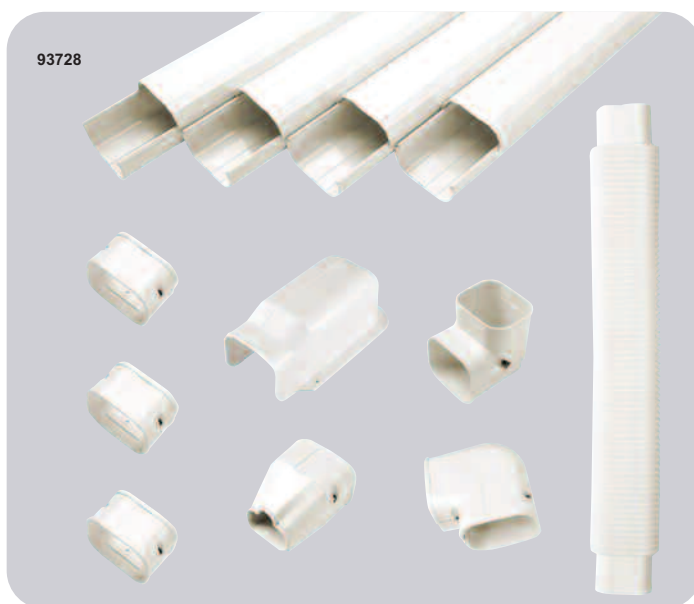

Accessories

MARS Designer Series - Plastic Cover And Base

MARS offers a broad selection of thermostat guards. Popular models available include metal, clear plastic and opaque plastic designs. MARS thermostat guards are ideal for protecting thermostats in schools, industrial plants institutions, public facilities and other areas where unauthorized tampering could be a problem. These attractive units feature a rugged, light weight and compact design. All units supplied with key. Extra keys are available. Order part #70236 for the BTG thermostat guard key.

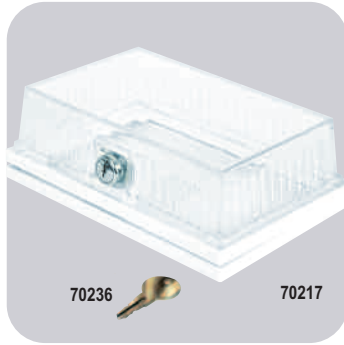

INSIDE DIMENSIONS (INCHES)	BASE	HEIGHT	WIDTH	DEPTH
	Solid	8	5	2 1/8
Ring	8	5	2 1/8	

MARS NO.	DESCRIPTION	BASE	MARS PACK	CASE QTY.
70217	BTG-DK clear plastic	Dual	1	12
70236	F336, extra key for all BTG guards		1	1

MARS Universal Series

MARS offers a broad selection of thermostat guards. Popular models available include metal, clear plastic and opaque plastic designs. MARS thermostat guards are ideal for protecting thermostats in schools, industrial plants institutions, public facilities and other areas where unauthorized tampering could be a problem. These attractive units feature a rugged, light weight and compact design. All units supplied with key. Extra keys are available. Order part #70236 for the BTG thermostat guard key.



PLASTIC INSIDE DIMENSIONS (INCHES)	BASE	HEIGHT	WIDTH	DEPTH
	Solid	9 5/16	5 5/8	3 9/16
	Ring	9 5/16	5 5/8	3 9/16
	METAL	BASE	HEIGHT	WIDTH
Solid	8	5 9/16	3 5/8	
Ring	8	5 9/16	3 5/8	

MARS NO.	DESCRIPTION	BASE	MARS PACK	CASE QTY.
70220	BTG-UK2 clear plastic	Dual	1	12
70223	BTG-UM metal	Solid	1	12
70224	BTG-UWM metal	Ring	1	12
70236	F336, extra key for all BTG guards		1	1

MARS Elite Series - Plastic Base

MARS offers a broad selection of thermostat guards. Popular models available include metal, clear plastic and opaque plastic designs. MARS thermostat guards are ideal for protecting thermostats in schools, industrial plants institutions, public facilities and other areas where unauthorized tampering could be a problem. These attractive units feature a rugged, light weight and compact design. All units supplied with key. Extra keys are available. Order part #70236 for the BTG thermostat guard key.



INSIDE DIMENSIONS (INCHES)	BASE	HEIGHT	WIDTH	DEPTH
Solid	4 3/4	4 1/2	2 3/4	

MARS NO.	DESCRIPTION	BASE	MARS PACK	CASE QTY.
70201	BTG-EK clear plastic cover	Solid	1	12
70236	F336, extra key for all BTG guards		1	1

MARS Classic Series - Plastic Base

MARS offers a broad selection of thermostat guards. Popular models available include metal, clear plastic and opaque plastic designs. MARS thermostat guards are ideal for protecting thermostats in schools, industrial plants institutions, public facilities and other areas where unauthorized tampering could be a problem. These attractive units feature a rugged, light weight and compact design. All units supplied with key. Extra keys are available. Order part #70236 for the BTG thermostat guard key.



INSIDE DIMENSIONS (INCHES)	BASE	HEIGHT	WIDTH	DEPTH
Solid	6 1/4	5 5/8	3 3/16	
Ring	6 1/4	5 5/8	3 3/16	

MARS NO.	DESCRIPTION	BASE	MARS PACK	CASE QTY.
70205	BTG-K clear plastic cover	Dual	1	12
70236	F336, extra key for all BTG guards		1	1

Thermostat Guard Bases

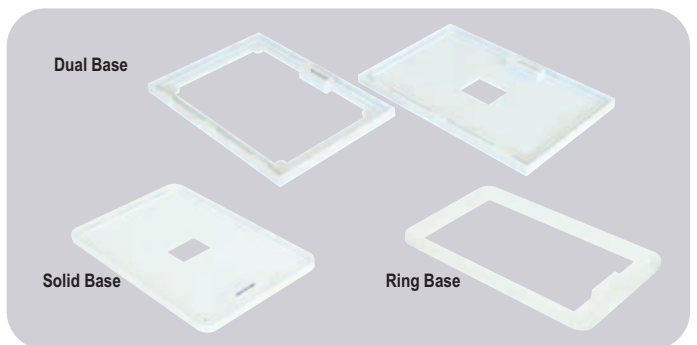

MARS Regal Series - Plastic Base

MARS offers a broad selection of thermostat guards. Popular models available include metal, clear plastic and opaque plastic designs. MARS thermostat guards are ideal for protecting thermostats in schools, industrial plants institutions, public facilities and other areas where unauthorized tampering could be a problem. These attractive units feature a rugged, light weight and compact design. All units supplied with key. Extra keys are available. Order part #70236 for the BTG thermostat guard key.



INSIDE DIMENSIONS (INCHES)	BASE	HEIGHT	WIDTH	DEPTH
	Solid	7 3/8	4 1/8	3 1/8
	Ring	7 3/8	4 1/8	3 1/8

MARS NO.	DESCRIPTION	BASE	MARS PACK	CASE QTY.
70210	BTG-RK clear plastic cover	Dual	1	12
70236	F336, extra key for all BTG guards		1	1

MARS Sentinel Series - Metal Cover And Base

MARS offers a broad selection of thermostat guards. Popular models available include metal, clear plastic and opaque plastic designs. MARS thermostat guards are ideal for protecting thermostats in schools, industrial plants institutions, public facilities and other areas where unauthorized tampering could be a problem. These attractive units feature a rugged, light weight and compact design. All units supplied with key. Extra keys are available. Order part #70236 for the BTG thermostat guard key.



INSIDE DIMENSIONS (INCHES)	BASE	HEIGHT	WIDTH	DEPTH
	Solid	6 1/2	5	3 1/16
	Ring	6 1/2	5	3 1/16

MARS NO.	DESCRIPTION	BASE	MARS PACK	CASE QTY.
70215	BTG-54VL metal hinged	Solid	1	12
70216	BTG-54VLW metal hinged	Ring	1	12
70236	F336, extra key for all BTG guards		1	1

Thermostat Guards Cross Reference

MARS NO.	BEKO	D Teck	SUPCO
70201	BTG EK	585-TG5	BTG EK
70205	BTG K clear plst	585-TG2	BTG K
70210	BTG RK clear plastic	585-TG1	BTG-RK
70215	BTG 54VL metal	585-TG7	BTG-54 VL
70216	BTG 54VLW hinged metal	585-TG8	BTG-54VLW
70217	BTG DK clear plastic	585-TG6	BTG-DK
70220	BTG UK2 clear plastic	585-TG	BTG-UK2
70223	BTG UM metal	585-TG3	BTG-UM
70224	BTG UWM hinged metal	585-TG4	BTG-UWM
70236	F336 key		

Universal Cover/Guard

Helps prevent tampering and unauthorized adjustments to your thermostat, helping to control your energy usage.



- Fits Thermostats up to 7.25"W x 4.75"H x 2.25"D
- Back plate Dimensions:
 - Exterior 9.25" x 6"
 - Interior 4.75" x 7"
- Easy Installation
- Tape included to seal off thermostat wire to prevent air penetration
- Wall cover included to create a clean look
- Mounting Screws and Anchors included



MARS NO.	DESCRIPTION	PACK QTY	CASE QTY
70256	Universal Thermostat Cover/Guard	1	24

Accessories

I-T-E Circuit Breakers Plug-In Interchangeable Type-Bulk

- For applications that require plug in
- Space saving design allows to fit a 1" panel space
- UL listed



SIEMENS
I-T-E® Electrical Products

10,000 KA interrupting rating

MARS NO.	DESCRIPTION	MARS PACK	CASE QTY.
83200	15a- 120/240 VAC, 1 pole	1	6
83201	20a- 120/240 VAC, 1 pole	1	6
83220	15a- 120/240 VAC, 2 pole	1	3
83221	20a- 120/240 VAC, 2 pole	1	3
83222	25a- 120/240 VAC, 2 pole	1	3
83223	30a- 120/240 VAC, 2 pole	1	3
83224	35a- 120/240 VAC, 2 pole	1	3
83225	40a- 120/240 VAC, 2 pole	1	3
83226	45a- 120/240 VAC, 2 pole	1	3
83227	50a- 120/240 VAC, 2 pole	1	3
83228	60a- 120/240 VAC, 2 pole	1	3
83229	70a- 120/240 VAC, 2 pole	1	3
83230	80a- 120/240 VAC, 2 pole	1	3
83231	90a- 120/240 VAC, 2 pole	1	3
83232	100a- 120/240 VAC, 2 pole	1	3

I-T-E Circuit Breakers Plug-In Interchangeable Type-Carded

- For applications that require plug in
- 10K AIC
- Space saving design allows to fit a 1" panel space
- UL listed



SIEMENS
I-T-E® Electrical Products

10,000 KA interrupting rating

MARS NO.	DESCRIPTION	MARS PACK	CASE QTY.
83537	20a- 120/240 VAC, 2 pole	1	3
83538	30a- 120/240 VAC, 2 pole	1	3
83539	40a- 120/240 VAC, 2 pole	1	3
83540	50a- 120/240 VAC, 2 pole	1	3
83541	60a- 120/240 VAC, 2 pole	1	3

General Electric Circuit Breakers-Bulk



- Compact size, 1/2" THQP or 1" THQL
- Box type terminals
- Copper to copper connections with corrosion resisting tin plated stabs
- Exceeds UL, NEMA, ANSI, CSA requirements



MARS NO.	DESCRIPTION	MARS PACK	CASE QTY.
83527	30a- 120/240 VAC, THQP 2 pole	1	5
83431	20a- 120/240 VAC, THQL 1 pole	1	10
83436	30a- 120/240 VAC, THQL 2 pole	1	5
83438	40a- 120/240 VAC, THQL 2 pole	1	5
83439	50a- 120/240 VAC, THQL 2 pole	1	5
83440	60a- 120/240 VAC, THQL 2 pole	1	5
83444	100a- 120/240 VAC, THQL 2 pole	1	5

GE Replacement Breakers For Square D



MARS offers GE replacement circuit breakers for Square D QO® load centers. These Q line series circuit breakers lower your inventory costs by providing a single source for new construction & Square D QO® retrofit. These UL classified GE breakers are for use in place of Square D type QO circuit breakers.



Square D QO® load centers for which GE/MARS offers UL classified replacement circuit breakers:

S70A Q02-4L50TTS Q02-4L70F/S Q02-4L70RB Q02-4L70TS Q02L30S Q02L30TTS Q02L40RB Q02TR Q04-7M70TTS	Q020-30M150RB Q020-30M150TF/S Q024L150 Q024M150 Q030L150 Q030M150RB Q030M150RB	Q06-12L100RBCU Q06-12L100TF/S Q06-12M125FTRB Q08-16L100DF/S Q08-16L100DFCU/S Q08-16L100FF/S Q08-16L100F/S Q08-16L100RB Q08-16L100RBCU Q08-16L100TF/S Q012M100RB Q016M100RB Q020M100RB	Q02100BNF/S Q024M100RB 125A Q06-12M125FTRB Q012-24L125 Q012-24L125RB Q012L125 Q012L125RB Q016-24L125 Q016-24L125RB Q016L125 Q020-24L125	Q002L125 Q02125BNF/S Q024L125 Q012L125RB Q024M125RB 225A Q040M225 Q042L225 Q042L225RB 200A Q08-16M200FTRB	Q012L200 Q012L200RB Q020-30M200RB Q020-40M200 Q020-40M200F/S Q024M200 Q030-40L200 Q030-40L200RB Q030-40M200 Q030L200 Q030L200RB Q040M200RB
--	--	---	--	---	---

MARS NO.	DESCRIPTION	GENO.	SQUARE D NO.
83574	20A-2P	THQO2120	QO220
83575	30A-2P	THQO2130	QO230
83576	40A-2P	THQO2140	QO240
83577	50A-2P	THQO2150	QO250
83578	60A-2P	THQO2160	QO260



Circuit Breakers

Zbreaker is the same circuit breaker now found on many high-end transformers and systems. It protects from damage caused by shorts, overheating, or wiring problems. A sticker is included so that, if the Tech desires, he can inform his customer where to press the "reset" button and possibly save a midnight service call. Kit includes wires and pre-installed terminals that allow you to easily plug it in to the connectors where a plastic-type fuse existed.

- Crystal-Clear Clamshell Package with Hanging Hole
- Full-Color Insert with Instructions



MARS NO.	DESCRIPTION	MARS PACK
08574	3 Amp Circuit Breaker	1
08575	5 Amp Circuit Breaker	1

I-T-E® EQ® Load Center Enclosures



I-T-E EQ® load centers with main lugs feature a combination trim boxed in one package.

- The trim fits both surface and flush mounting applications saving money and space
- Interiors offer removal in seconds
- Single phase, 3-wire design, 120/240 VAC
- One piece Albus bar construction. Designed for use only with I-T-E circuit breakers. UL listed
- Rated for 100,000 A IR
- Exclusive split neutral
- Main lugs and neutral on same plane, same drive
- Simple upper pan adjustment after trim is installed
- UL listed for 60/75 °C conductors
- 100% circuit breaker twistouts
- Indoor and outdoor enclosures available



MARS NO.	DESCRIPTION	MARS PACK
83271	60a-2 pole 4 circuit, surface branch panel - type 1	1
83273	125a-4 pole 8 circuit, surface branch panel - type 1	1

Outdoor Enclosures - Type 3R

- Single phase, 3 wire SN
- 120/240V
- Uses HA type hub



MARS NO.	DESCRIPTION	MARS PACK
83277	60a-2 pole 4 circuit, outdoor enclosure	1
83278	125a-4 pole 8 circuit, outdoor enclosure	1

Cartridge Fuses, Type TRS



SmartSpot blown-fuse indicator

With SmartSpot you'll find the open fuse FAST. When a fuse opens, the SmartSpot indicator on the label of the fuse senses it and turns from SILVER to eye-catching RED.

And it stays RED so you can spot the open fuse quickly and safely.

Just open a panel and scan. Wherever you see any red in a SmartSpot indicator, you know the fuse is open.

This is a big advantage to contractors/service personnel because it helps them to identify very quickly what fuse needs to be changed thereby avoiding costly downtime.

You'll find SmartSpot on all of the most widely used industry standard fuses such as Class RK5, RK1, and Class J.

Time delay (class RK5, 600 volt)

MARS NO.	DESCRIPTION	MARS PACK	CASE QTY.
82103*	2/10a - 600V, TRS fuse	10	100
82106*	1/2a - 600V, TRS fuse	10	100
82109*	1a - 600V, TRS fuse	10	100
82110*	1.6a - 600V, TRS fuse	10	100
82111*	2a - 600V, TRS fuse	10	100
82112*	2.25a - 600V, TRS fuse	10	100
82124*	5a - 600V, TRS fuse	10	200
82125*	6a - 600V, TRS fuse	10	200
82132	10a - 600V, TRS fuse	10	200
82133	12a - 600V, TRS fuse	10	200
82134	15a - 600V, TRS fuse	10	200
82136	20a - 600V, TRS fuse	10	200
82137	25a - 600V, TRS fuse	10	200
82138	30a - 600V, TRS fuse	10	200
82139	35a - 600V, TRS fuse	10	100
82140	40a - 600V, TRS fuse	10	100
82147	45a - 600V, TRS fuse	10	100
82141	50a - 600V, TRS fuse	10	100
82142	60a - 600V, TRS fuse	10	100
82143	70a - 600V, TRS fuse	5	5
82144	80a - 600V, TRS fuse	5	5
82145	90a - 600V, TRS fuse	5	5
82146	100a - 600V, TRS fuse	5	5
82154	110a - 600V, TRS fuse	1	1
82148	125a - 600V, TRS fuse	1	1
82149	150a - 600V, TRS fuse	1	1
82150	175a - 600V, TRS fuse	1	1
82151	200a - 600V, TRS fuse	1	1
82152	250a - 600V, TRS fuse	1	1
82153	300a - 600V, TRS fuse	1	1

* NOTE: SmartSpot indicating fuse not available below 8 amps. 60a and up are blade type.

Accessories

Cartridge Fuses, Type TR



SmartSpot blown-fuse indicator

With SmartSpot you'll find the open fuse FAST. When a fuse opens, the SmartSpot indicator on the label of the fuse senses it and turns from SILVER to eye-catching RED.

And it stays RED so you can spot the open fuse quickly and safely.

Just open a panel and scan. Wherever you see any red in a SmartSpot indicator, you know the fuse is open.

This is a big advantage to contractors/service personnel because it helps them to identify very quickly what fuse needs to be changed thereby avoiding costly downtime.

You'll find SmartSpot on all of the most widely used industry standard fuses such as Class RK5, RK1, and Class J.

Time delay (class RK5, 250 volt)

MARS NO.	DESCRIPTION	MARS PACK	CASE QTY.
82006*	1/2a - 250V, TR fuse	10	100
82009*	1a - 250V, TR fuse	10	100
82016*	2a - 250V, TR fuse	10	100
82017*	2 1/2a - 250V, TR fuse	10	100
82019*	3a - 250V, TR fuse	10	100
82020*	3 2/10a - 250V, TR fuse	10	100
82021*	4a - 250V, TR fuse	10	100
82024*	5a - 250V, TR fuse	10	100
82025*	5 6/10a - 250V, TR fuse	10	100
82026*	6a - 250V, TR fuse	10	100
82027*	6 1/4a - 250V, TR fuse	10	100
82029*	7a - 250V, TR fuse	10	100
82030	8a - 250V, TR fuse	10	100
82032	10a - 250V, TR fuse	10	100
82033	12a - 250V, TR fuse	10	100
82034	15a - 250V, TR fuse	10	100
82035	17 1/2a - 250V, TR fuse	10	100
82036	20a - 250V, TR fuse	10	100
82037	25a - 250V, TR fuse	10	100
82038	30a - 250V, TR fuse	10	100
82039	35a - 250V, TR fuse	10	100
82040	40a - 250V, TR fuse	10	100
82041	45a - 250V, TR fuse	10	100
82042	50a - 250V, TR fuse	10	100
82043	60a - 250V, TR fuse	10	100
82044	70a - 250V, TR fuse	5	100
82045	80a - 250V, TR fuse	5	100
82046	90a - 250V, TR fuse	5	100
82047	100a - 250V, TR fuse	5	100
82048	110a - 250V, TR fuse	1	1
82049	125a - 250V, TR fuse	1	1
82050	150a - 250V, TR fuse	1	1
82051	175a - 250V, TR fuse	1	1
82052	200a - 250V, TR fuse	1	1
82053	225a - 250V, TR fuse	1	1
82054	350a - 250V, TR fuse	1	1
82056	400a - 250V, TR fuse	1	1
82055	600a - 250V, TR fuse	1	1

* NOTE: SmartSpot indicating fuse not available below 8 amps. 60a and up are blade type.

Midget Fast Acting Fuses, Type ATM



Fast acting

Applications:

- For supplemental protection of wide variety of circuits up to 600VAC with 100kA I.R.



MARS NO.	DESCRIPTION	MARS PACK	CASE QTY.
82907	1/2a - 600V, ATM fuse	10	100
82909	1a - 600V, ATM fuse	10	100
82910	1 1/2a - 600V, ATM fuse	10	100
82911	2a - 600V, ATM fuse	10	100
82916	3a - 600V, ATM fuse	10	100
82912	4a - 600V, ATM fuse	10	100
82913	5a - 600V, ATM fuse	10	100
82914	6a - 600V, ATM fuse	10	100
82918	7a - 600V, ATM fuse	10	100
82915	8a - 600V, ATM fuse	10	100
82917	10a - 600V, ATM fuse	10	100
82919	15a - 600V, ATM fuse	10	100
82920	20a - 600V, ATM fuse	10	100
82922	30a - 600V, ATM fuse	10	100

Specialty Fuses



MARS NO.	DESCRIPTION	MARS PACK	CASE QTY.
Small Dimension (Electronic) Fuses, 5 x 20mm — N. American Standards, Fast Acting			
82881	GGM 2 250V fuse	5	5
82879	GGM .5 250V fuse	5	5
82882	GGM 10 250V fuse	10	10
Small Time Delay Fuses, Rejection Style (PC Boards and small Dimension Fuses)			
82880	GMQ 3.2a, 300V fuse	5	100
82884	GMQ4a, 300V fuse	5	100
Fast Acting Size Rejection Special Type Fuse (PC Boards and small Dimension Fuses)			
82980	GLQ 3.0a, 300V fuse	5	100
Fast Acting Non Rejecting Special Type Fuse (Low voltage supplementary fuses)			
82886	GLR 1.5a, 300V fuse	5	100
82887	GLR 1.6a, 300V fuse	5	100
82891	GLR 10a, 300V fuse	5	100
82890	GLR 15a, 300V fuse	5	100
82883	GSC 1a, 300V fuse	5	100

Specialty Fuses (Cont.)



Specialty Fuses (Cont.)



MARS NO.	DESCRIPTION	MARS PACK	CASE QTY.
Slo Blo Fuses			
82439	3AB-326 1a, 250V fuse	5	100
82442	3AB-326 5a, 250V fuse	5	100
82445	3AB-326 15a, 250V fuse	5	100
82444	3AB-326 20a, 250V fuse	5	100

MARS NO.	DESCRIPTION	MARS PACK	CASE QTY.
Time Delay, 1/4 x 1 1/4", Glass Type Fuses (PC Boards and small Dimension Fuses)			
82978	WVR heat limiter	10	10
82979	WUR heat limiter	10	10

MARS NO.	DESCRIPTION	MARS PACK	CASE QTY.
Small Dimension Time Delay Non Rejecting Special Fuse (PC Boards and small Dimension Fuses)			
82888	SMF 3.2a, (LMF 3.2)	5	5

MARS NO.	DESCRIPTION	MARS PACK	CASE QTY.
Low Voltage Supplementary Time Delay Fuse, 10X38 or 13/32 X 1-1/2 Size			
82956	TRM .2a, 250V fuse	10	100
82953	TRM .8a, 250V fuse	10	100
82958	TRM 1a, 250V fuse	10	100
82959	TRM 2a, 250V fuse	10	100
82960	TRM 3a, 250V fuse	10	100
82963	TRM 4a, 250V fuse	10	100
82965	TRM 5a, 250V fuse	10	100
82946	TRM 6a, 250V fuse	10	100
82954	TRM 8a, 250V fuse	10	100
82969	TRM 10a, 250V fuse	10	100
82970	TRM 15a, 250V fuse	10	100
82972	TRM 20a, 250V fuse	10	100
82973	TRM 25a, 250V fuse	10	100
82974	TRM 30a, 250V fuse	10	100

MARS NO.	DESCRIPTION	MARS PACK	CASE QTY.
Low Voltage Branch Circuit Rated Fuses, R Class CC			
82977	ATMR -2a, 600V fuse	10	100
82966	ATMR -3a, 600V fuse	10	100
82967	ATMR -4a, 600V fuse	10	100
82971	ATMR -10a, 600V fuse	10	100
82976	ATMR -12a, 600V fuse	10	100
82968	ATMR -15a, 600V fuse	10	100
82981	ATMR 20a, 600V fuse	10	100

MARS NO.	DESCRIPTION	MARS PACK	CASE QTY.
Low Voltage Supplementary Fast Acting Fuses			
82608	BLS/BBS 1a, 250V fuse	10	100
82609	BLS/BBS 2a, 250V fuse	10	100
82610	BLS/BBS 3a, 250V fuse	10	100
82611	BLS/BBS 4a, 600V fuse	10	100
82612	BLS/BBS 5a, 600V fuse	10	100

MARS NO.	DESCRIPTION	MARS PACK	CASE QTY.
Medium Voltage Fuses Class J Fast Acting			
82158	A4J - 6a, 600V fuse	10	100
82160	A4J - 15a, 600V fuse	10	100
82161	A4J - 20a, 600V fuse	10	100
82163	A4J - 30a, 600V fuse	10	100
82169	A3T - 40a, 600V fuse	10	100
82170	A6T - 25a, 600V fuse	10	100
82179	A6T - 30a, 600V fuse	10	100
82181	A6T - 35a, 600V fuse	10	100

MARS NO.	DESCRIPTION	MARS PACK	CASE QTY.
Fuse Reducer			
82975	263M/H632 fuse reducer (1 pair)	1	10

MARS NO.	DESCRIPTION	MARS PACK	CASE QTY.
Automotive Blade Type Fuse Acting 32V DC			
82230	ATC - 3a, auto blade fuse(5 pk)	1	5
82232	ATC - 4a, auto blade fuse	5	5
82231	ATC - 5a, auto blade fuse (5 pk)	1	5
82233	ATC - 7.5a, auto blade fuse	1	5
82234	ATC - 10a, auto blade fuse	5	5
82235	ATC - 15a, auto blade fuse	5	5
82236	ATC - 20a, auto blade fuse	5	5
82237	ATC - 25a, auto blade fuse	5	5
82238	ATC - 30a, auto blade fuse	5	5

MARS NO.	DESCRIPTION	MARS PACK	CASE QTY.
ATDR Time Delay Class CC (Small motors, Contactors, Branch Circuit Protection)			
82226	ATDR - 6.25a, 600V fuse, class CC	10	10
82228	ATDR - 10a, 600V fuse	10	10

MARS NO.	DESCRIPTION	MARS PACK	CASE QTY.
ATQR Time Delay Class CC (Control Transformers, Solenoids, Inductive Loads)			
82227	ATQR - 15a, 600V fuse	10	10

Accessories

Gen. Purpose Cartridge Fuses, Type OT



One time non-renewable,
Class K-5

MARS NO.	DESCRIPTION	MARS PACK	CASE QTY.
82210	10a - 250V, OT10 Fuse	10	100
82212	15a - 250V, OT15 Fuse	10	100
82213	20a - 250V, OT20 Fuse	10	100
82214	25a - 250V, OT25 Fuse	10	100
82215	30a - 250V, OT30 Fuse	10	100
82216	35a - 250V, OT35 Fuse	10	100
82217	40a - 250V, OT40 Fuse	10	100
82218	45a - 250V, OT45 Fuse	10	100
82219	50a - 250V, OT50 Fuse	10	100
82220	60a - 250V, OT60 Fuse	10	100
82221	70a - 250V, OT70 Fuse	5	100
82224	100a - 250V, OT100 Fuse	5	100

Gen. Purpose Cartridge Fuses, Type OTS



One time non-renewable,
Class K-5

Applications:

- Feeders
- Branch circuits
- Resistive heating
- Residential and small commercial installations



MARS NO.	DESCRIPTION	MARS PACK	CASE QTY.
82249	10a - 600V, OTS fuse	10	100
82251	15a - 600V, OTS fuse	10	100
82252	20a - 600V, OTS fuse	10	100
82253	25a - 600V, OTS fuse	10	100
82254	30a - 600V, OTS fuse	10	100
82255	35a - 600V, OTS fuse	10	100
82256	40a - 600V, OTS fuse	10	100
82259	60a - 600V, OTS fuse	10	100
82264	100a - 600V, OTS fuse	5	100

Midget Fuses, Type OTM



Fast acting

Applications:

- Supplemental protection of circuits up to 250VAC and 10kA



MARS NO.	DESCRIPTION	MARS PACK	CASE QTY.
82702	2a - 250V, OTM fuse	10	100
82705	5a - 250V, OTM fuse	10	100
82710	15a - 250V, OTM fuse	10	100
82711	20a - 250V, OTM fuse	10	100

Midget Time Delay Fuses, Type ATQ



Time delay

(12 seconds @ 200% rating) for circuits with high inrush current

Applications:

- Supplemental protection if lighting, solenoid, motor and transformer circuits



MARS NO.	DESCRIPTION	MARS PACK	CASE QTY.
82932	1/4a - 500V, ATQ fuse	10	100
82933	1/2a - 500V, ATQ fuse	10	100
82936	1a - 500V, ATQ fuse	10	100
82941	2a - 500V, ATQ fuse	10	100
82942	3a - 500V, ATQ fuse	10	100
82943	4a - 500V, ATQ fuse	10	100
82944	5a - 500V, ATQ fuse	10	100
82945	6a - 500V, ATQ fuse	10	100
82714	7a - 500V, ATQ fuse	10	100
82947	10a - 500V, ATQ fuse	10	100
82940	12a - 500V, ATQ fuse	10	100
82952	15a - 500V, ATQ fuse	10	100
82948	20a - 500V, ATQ fuse	10	100
82949	25a - 500V, ATQ fuse	10	100
82951	30a - 500V, ATQ fuse	10	100

Ceramic Body Fast Acting Fuses, Type GAB



- Ceramic body
- Fast acting
- 1/4" x 1-1/4"



82403

MARS NO.	DESCRIPTION	MARS PACK	CASE QTY.
82403	1/2a - 250V, GAB ceramic fuse	5	5
82404	1a - 250V, GAB ceramic fuse	5	5
82402	1 1/2a - 250V, GAB ceramic fuse	5	5
82405	2a - 250V, GAB ceramic fuse	5	100
82406	2 1/2a - 250V, GAB ceramic fuse	5	5
82407	3a - 250V, GAB ceramic fuse	5	5
82408	4a - 250V, GAB ceramic fuse	5	5
82409	5a - 250V, GAB ceramic fuse	5	5
82410	6a - 250V, GAB ceramic fuse	5	5
82411	7a - 250V, GAB ceramic fuse	5	5
82412	8a - 250V, GAB ceramic fuse	5	5
82413	10a - 250V, GAB ceramic fuse	5	5
82414	12a - 250V, GAB ceramic fuse	5	5
82415	15a - 250V, GAB ceramic fuse	5	5
82416	20a - 250V, GAB ceramic fuse	5	5
82417	25a - 250V, GAB ceramic fuse	5	5
82418	30a - 250V, GAB ceramic fuse	5	5

Electronic/Glass Fuses, Type GGX



- Glass body
- Fast acting
- 1/4" x 1"



82878

MARS NO.	DESCRIPTION	MARS PACK	CASE QTY.
82484	1/2a - 250V, GGX glass fuse	5	100
82486	1a - 250V, GGX glass fuse	5	100
82488	2a - 250V, GGX glass fuse	5	5
82491	5a - 125V, GGX glass fuse	5	5
82877	3a - 125V, GGX glass fuse	5	5

Glass Body Non-Time Delay Fuses, Type GGC



- Glass body
- Fast acting
- 1/4" x 1-1/4"



82448

MARS NO.	DESCRIPTION	MARS PACK	CASE QTY.
82448	1/10a - 250V, GGC glass fuse	5	5
82450	1/4a - 250V, GGC glass fuse	5	100
82451	3/10a - 250V, GGC glass fuse	5	5
82453	1/2a - 250V, GGC glass fuse	5	100
82455	3/4a - 250V, GGC glass fuse	5	5
82456	1a - 250V, GGC glass fuse	5	100
82457	1 1/4a - 250V, GGC glass fuse	5	5
82458	1 1/2a - 250V, GGC glass fuse	5	100
82460	2a - 250V, GGC glass fuse	5	100
82461	2 1/2a - 250V, GGC glass fuse	5	100
82462	3a - 250V, GGC glass fuse	5	100
82459	3 2/10a - 250V, GGC glass fuse	5	100
82463	4a - 250V, GGC glass fuse	5	100
82464	5a - 250V, GGC glass fuse	5	5
82465	6a - 250V, GGC glass fuse	5	100
82466	7 1/2a - 250V, GGC glass fuse	5	5
82467	8a - 250V, GGC glass fuse	5	100
82468	10a - 250V, GGC glass fuse	5	100
82474	12a - 125V, GGC glass fuse	5	100
82469	15a - 125V, GGC glass fuse	5	100
82471	20a - 32V, GGC glass fuse	5	100
82472	25a - 32V, GGC glass fuse	5	5
82473	30a - 32V, GGC glass fuse	5	5

Electronic/Glass Fuses, Type GDG



- Glass body
- Time Delay
- 13/16" X 3/16"

MARS NO.	DESCRIPTION	MARS PACK	CASE QTY.
82476	3-15/100A-250V, GDG glass fuse	5	5

Accessories

Class G Fuses 480 Volt, 600 Volt Type AG = Type SC

Time delay (above 5A)
current limiting

Applications:

- Lighting
- Heating
- Appliances
- Branch circuits

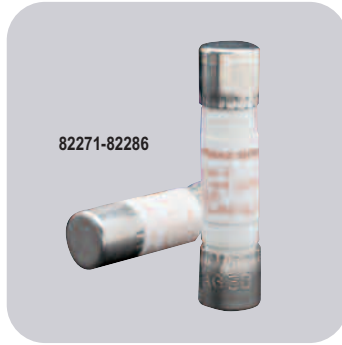

MARS NO.	DESCRIPTION	MARS PACK	CASE QTY.
82271	1a - 600V, AG fuse	4	100
82290	2a - 600V, AG fuse	4	100
82272	3a - 600V, AG fuse	4	100
82291	4a - 600V, AG fuse	4	100
82273	5a - 600V, AG fuse	4	100
82274	6a - 600V, AG fuse	4	100
82275	8a - 600V, AG fuse	4	100
82276	10a - 600V, AG fuse	4	100
82278	15a - 600V, AG fuse	4	100
82279	20a - 600V, AG fuse	4	100
82280	25a - 480V, AG fuse	4	100
82281	30a - 480V, AG fuse	4	100
82282	35a - 480V, AG fuse	2	100
82283	40a - 480V, AG fuse	2	100
82285	50a - 480V, AG fuse	2	100
82286	60a - 480V, AG fuse	2	100

Glass Body Time Delay Fuses, Type GDL



- Glass body
- Time delay
- 1/4" x 1 1/4"



MARS NO.	DESCRIPTION	MARS PACK	CASE QTY.
82502	1a - 250V, GDL glass fuse	5	100
82505	1.5a - 250V, GDL glass fuse	5	100
82507	2a - 250V, GDL glass fuse	5	100
82508	2.5a - 250V, GDL glass fuse	5	100
82510	3a - 250V, GDL glass fuse	5	100
82512	4a - 250V, GDL glass fuse	5	100
82513	5a - 250V, GDL glass fuse	5	100
82514	7a - 250V, GDL glass fuse	5	100
82517	8a - 250V, GDL glass fuse	5	100
82518	10a - 125V, GDL glass fuse	5	100
82519	15a - 125V, GDL glass fuse	5	100

Dual Element, Time Delay (Type S) UL 125V



Plug fuses all UL listed;
CSA models also listed

Rejection Time delay,
tamper resistant



MARS NO.	DESCRIPTION	MARS PACK	CASE QTY.
82307	1 1/4a, S plug fuse	4	100
82308	1 6/10a, S plug fuse	4	100
82311	2a, S plug fuse	4	100
82313	2 1/2a, S plug fuse	4	100
82315	3a, S plug fuse	4	100
82316	3 2/10a, S plug fuse	4	100
82318	4a, S plug fuse	4	100
82320	5a, S plug fuse	4	100
82323	6 1/4a, S plug fuse	4	100
82325	8a, S plug fuse	4	100
82326	9a, S plug fuse	4	100
82327	10a, S plug fuse	4	100
82328	12a, S plug fuse	4	100
82330	15a, S plug fuse	4	100
82331	20a, S plug fuse	4	100
82332	25a, S plug fuse	4	100
82333	30a, S plug fuse	4	100

Dual Element Time Delay Type S Clamshell Packaging For Merchandisers



Rejection Time delay,
tamper resistant



MARS NO.	DESCRIPTION	MARS PACK
82745	15a, S plug fuse 125V, (6 pk)	1
82746	20a, S plug fuse 125V, (6 pk)	1
82747	25a, S plug fuse 125V, (6 pk)	1
82748	30a, S plug fuse 125V, (6 pk)	1

Dual Element, Time Delay (Type T) UL 125V



- Low melting point temperatures
- Electronic heating and cycling load circuits



MARS NO.	DESCRIPTION	MARS PACK	CASE QTY.
82334	1 1/4a, T plug fuse	4	100
82337	2a, T plug fuse	4	100
82344	2.5a, T plug fuse	4	100
82338	3.2a, T plug fuse	4	100
82339	4a, T plug fuse	4	100
82340	5a, T plug fuse	4	100
82341	6 1/4a, T plug fuse	4	100
82342	8a, T plug fuse	4	100
82343	10a, T plug fuse	4	100
82660	15a, T plug fuse	4	100
82661	20a, T plug fuse	4	100
82662	30a, T plug fuse	4	100

Dual Element, Time Delay (Type TL) UL 125V



MARS NO.	DESCRIPTION	MARS PACK	CASE QTY.
82346	15a, TL plug fuse	4	100
82348	25a, TL plug fuse	4	100
82349	30a, TL plug fuse	4	100

Dual Element, Time Delay (Type TD) UL 125V



- Low melting temperature element
- Electronic heating and cycling load circuits



MARS NO.	DESCRIPTION	MARS PACK	CASE QTY.
82350	15a, TD plug fuse-CSA	4	100
82351	20a, TD plug fuse-CSA	4	100
82352	25a, TD plug fuse-CSA	4	100
82353	30a, TD plug fuse-CSA	4	100

Dual Element Time Delay Type TL Clamshell Packaging For Merchandisers



MARS NO.	DESCRIPTION	MARS PACK
82736	20a, 125V, TL plug fuse (6 pk)	1
82737	25a, 125V, TL plug fuse (6 pk)	1
82738	30a, 125V, TL plug fuse (6 pk)	1

S Plug Fuse Adapters, UL 125



Type S adapters screw into the base and allow Type S fuses to be installed. Type S adapters prevent the wrong size fuse from being used.



MARS NO.	DESCRIPTION	MARS PACK	CASE QTY.
82375	2 1/2a, S plug fuse	4	100
82379	6 1/4a, S plug fuse	4	100
82382	15a, S plug fuse	4	100
82383	20a, S plug fuse	4	100
82384	30a, S plug fuse	4	100

Dual Element, Time Delay (Type T) UL 125V



- Low melting point temperatures
- Electronic heating and cycling load circuits



MARS NO.	DESCRIPTION	MARS PACK	CASE QTY.
82334	1 1/4a, T plug fuse	4	100
82337	2a, T plug fuse	4	100
82344	2.5a, T plug fuse	4	100
82338	3.2a, T plug fuse	4	100
82339	4a, T plug fuse	4	100
82340	5a, T plug fuse	4	100
82341	6 1/4a, T plug fuse	4	100
82342	8a, T plug fuse	4	100
82343	10a, T plug fuse	4	100
82660	15a, T plug fuse	4	100
82661	20a, T plug fuse	4	100
82662	30a, T plug fuse	4	100

Dual Element, Time Delay (Type TL) UL 125V



MARS NO.	DESCRIPTION	MARS PACK	CASE QTY.
82346	15a, TL plug fuse	4	100
82348	25a, TL plug fuse	4	100
82349	30a, TL plug fuse	4	100

Dual Element, Time Delay (Type TD) UL 125V



- Low melting temperature element
- Electronic heating and cycling load circuits



MARS NO.	DESCRIPTION	MARS PACK	CASE QTY.
82350	15a, TD plug fuse-CSA	4	100
82351	20a, TD plug fuse-CSA	4	100
82352	25a, TD plug fuse-CSA	4	100
82353	30a, TD plug fuse-CSA	4	100

Dual Element Time Delay Type TL Clamshell Packaging For Merchandisers



MARS NO.	DESCRIPTION	MARS PACK
82736	20a, 125V, TL plug fuse (6 pk)	1
82737	25a, 125V, TL plug fuse (6 pk)	1
82738	30a, 125V, TL plug fuse (6 pk)	1

S Plug Fuse Adapters, UL 125



Type S adapters screw into the base and allow Type S fuses to be installed. Type S adapters prevent the wrong size fuse from being used.



MARS NO.	DESCRIPTION	MARS PACK	CASE QTY.
82375	2 1/2a, S plug fuse	4	100
82379	6 1/4a, S plug fuse	4	100
82382	15a, S plug fuse	4	100
82383	20a, S plug fuse	4	100
82384	30a, S plug fuse	4	100

Accessories

Fast Acting,
(Type W) UL 125V



"W" Fuse

MARS NO.	DESCRIPTION	MARS PACK	CASE QTY.
82360	10a, W plug fuse	4	100
82363	15a, W plug fuse	4	100
82364	20a, W plug fuse	4	100
82365	25a, W plug fuse	4	100
82366	30a, W plug fuse	4	100

Dual Element,
Time Delay Fuse -
Type W Clamshell
Packaging For
Merchandisers



MARS NO.	DESCRIPTION	MARS PACK
82756	20a, 125V, W plug fuse (6 pk)	1
82757	25a, 125V, W plug fuse (6 pk)	1
82758	30a, 125V, W plug fuse (6 pk)	1

Fuse Blocks -
Class H & K 250 Volts



Mersen manufactures the highest quality 250 to 600 volt fuse blocks handling current capacities of 30 to 600 amperes. These durable fuse blocks are designed for class H, J, K, R, CC and Midget fuses. All blocks are UL listed and CSA certified.

Mersen fuse blocks feature a unique adder block which can be snapped on to form multi-pole segmented blocks of as many poles as desired. Multiple pole blocks thus formed save valuable space, are permanent, and can be added to in the future.

Fuse block insulators are constructed of either phenolic or molded polycarbonate. Three types of wire connectors are used. Screw type is for copper wire with terminals. Pressure plate type is for bare copper wire where vibration may be a factor. Box type connectors are the most durable and versatile for stranded or solid wire. All fuse clips are one piece high-conductivity tin-plated copper for low resistance connections and cool operation.

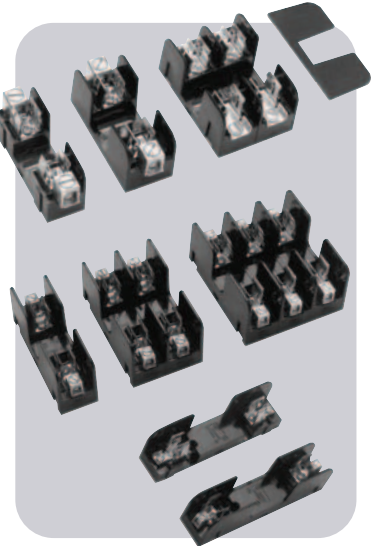

MARS NO.	DESCRIPTION	MARS PACK	CASE QTY.
83010	Adder 30 amp - Al box	1	50
83011	1 pole 30 amp - Al box	1	50
83012	1 pole 30 amp - screw	1	50
83013	2 pole 30 amp - screw	1	50
83017	2 pole 60 amp - Al box	5	25
83018	3 pole 60 amp - Al box	5	25

Fuse Blocks -
Midget Fuses 600 Volts



Mersen power distribution blocks (pdb), afford a safe, convenient way of splicing cables, splitting primary power into a variety of secondary circuits or providing a fixed junction tap - off point. Insulators are virtually unbreakable polycarbonate. Standard aluminum box connectors accommodate aluminum and copper wire. Connector bars are all one piece and tin plated. The pdbs are UL listed and CSA certified.

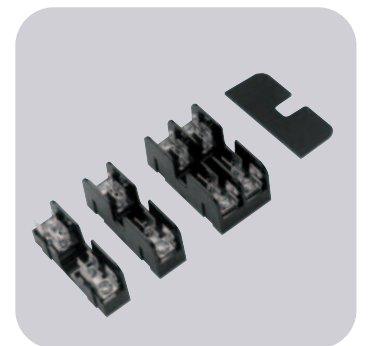

MARS NO.	DESCRIPTION	MARS PACK	CASE QTY.
83061	1 pole 30 amp - screw	1	50
83062	2 pole 30 amp - screw	1	25
83063	3 pole 30 amp - screw	1	25
83065	1 pole 30 amp - plate	1	50
83066	2 pole 30 amp - plate	1	25
83067	3 pole 30 amp - plate	1	25

Power Distribution Blocks - 600 Volts



MARS NO.	DESCRIPTION	MARS PACK	CASE QTY.
83090	1 pole pdb 1 to 4 #4-#14ga	1	50
83091	2 pole pdb 1 to 4 #4-#14ga	1	25
83092	3 pole pdb 1 to 4 #4-#14ga	1	25

Fuse Holders



MARS NO.	DESCRIPTION	MARS PACK	CASE QTY.
82994	panel mount glass holder 1/4" x 1 1/4" screw type knob	1	100
82995	panel mount midget holder 13/32" x 1 1/2" bayonet knob	1	100
82996	base mount glass fuse block 1/4" x 1 1/4"	10	100
82997	in-line midget holder-screw cap	1	100
83001	in-line glass holder-screw cap (5 pk)	1	100
83002	in-line glass holder-snap cap (5 pk)	1	100
82989	HPF-SC fuse holder-panel mount	10	100
82990	HHB fuse holder	10	100
82991	HKP-HH fuse holder	1	10
82993	HRK fuse holder	10	100

JARD Fuses



Applications:

- Recommended for AC power distribution system mains, feeders, and branch circuits.
- Protection of motors and motor branch circuits.
- Protection of transformers and other inductive loads.
- All general-purpose applications including lighting, heating and other non-inductive loads.

Benefits:

- Superior overload and cycling capabilities.
- Current limiting provides component short-circuit protection.

Specifications:

Dual-Element Time-Delay

Voltage Rating: RK5 - 250Vac, RK5 - 600Vac

Amp Rating: 1/10 - 600A

Interrupting Rating: 200,000 RMS Symmetrical Amps

Current Limiting: RK5 Fuse

Agency Approvals:

UL Listed, Class RK5, CSA Certified, DC listed to UL standard 248 TRS only

Voltage Rating: RK5 250V

- Volts: 250VAC
- : 250VDC (.1-2.8A; 35-400A)
- : 160VDC (3-30A; 450-600A)

RK5 600V

- Volts: 600VAC
- : 600VDC (.1-12A; 70-600A)
- : 160VDC (15-60A)



RK5 Time Delay Fuse 250V

Replaces: TR, ECNR, FRNR, FLNR

RK5 Time Delay Fuse 600V

Replaces: TRS, ECSR, FRSR, FLRS

MARS NO.	DESCRIPTION	MARS PACK
81006	.5A - 250V	10
81009	1A - 250V	10
81016	2A - 250V	10
81017	2.5A - 250V	10
81019	3A - 250V	10
81020	3.2A - 250V	10
81021	4A - 250V	10
81024	5A - 250V	10
81025	5.6A - 250V	10
81026	6A - 250V	10
81027	6.25A - 250V	10
81029	7A - 250V	10
81030	8A - 250V	10
81032	10A - 250V	10
81033	12A - 250V	10
81034	15A - 250V	10
81035	17.5A - 250V	10
81036	20A - 250V	10
81037	25A - 250V	10
81038	30A - 250V	10
81039	35A - 250V	10
81040	40A - 250V	10
81041	45A - 250V	10
81042	50A - 250V	10
81043	60A - 250V	10
81044	70A - 250V	5
81045	80A - 250V	5
81046	90A - 250V	5
81047	100A - 250V	5
81048	110A - 250V	1
81049	125A - 250V	1
81050	150A - 250V	1
81051	175A - 250V	1
81052	200A - 250V	1
81053	225A - 250V	1
81054	350A - 250V	1
81056	400A - 250V	1
81055	600A - 250V	1

MARS NO.	DESCRIPTION	MARS PACK
81103	.2A - 600V	10
81106	.5A - 600V	10
81109	1A - 600V	10
81110	1.6A - 600V	10
81111	2A - 600V	10
81112	2.25A - 600V	10
81124	5A - 600V	10
81125	6A - 600V	10
81132	10A - 600V	10
81133	12A - 600V	10
81134	15A - 600V	10
81136	20A - 600V	10
81137	25A - 600V	10
81138	30A - 600V	10
81139	35A - 600V	10
81140	40A - 600V	10
81147	45A - 600V	10
81141	50A - 600V	10
81142	60A - 600V	10
81143	70A - 600V	5
81144	80A - 600V	5
81145	90A - 600V	5
81146	100A - 600V	5
81154	110A - 600V	1
81148	125A - 600V	1
81149	150A - 600V	1
81150	175A - 600V	1
81151	200A - 600V	1
81152	250A - 600V	1
81153	300A - 600V	1

Accessories

Fuses With A Resealable Plastic Pouch



MARS NO.	DESCRIPTION	MARS PACK
08569	3 Amp Standard Size Plastic, 25/pk	1
08570	5 Amp Standard Size Plastic, 25/pk	1
08571	Assorted Fuses, 25/pk	1

Fuses & Fuse Holders

Zebra Instruments offers a 4 pack Medium Duty (15A) standard size plastic fuses and fuse holder. This allows you to replace (or install) fuse protection for transformer outputs (and other devices) in HVAC systems.



MARS NO.	DESCRIPTION	MARS PACK
08568	Medium duty 15Amp Standard Size Plastic, 4/pk	1

Toggle Switches Without Ground

- Quick wire push in and side wire
- Constructed of impact resistant thermo-plastic

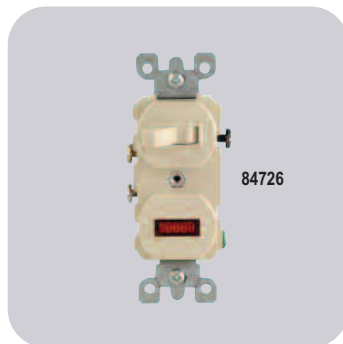

MARS NO.	DESCRIPTION	MARS PACK	CASE QTY.
84798	15a -120V, 1P, silent, ivory (bulk)	10	100
84726	15a -120/277V, 1P, switch w/pilot light (card)	1	100

Toggle Switches With Ground



- Quick wire push in and side wire
- Constructed of impact resistant thermo-plastic

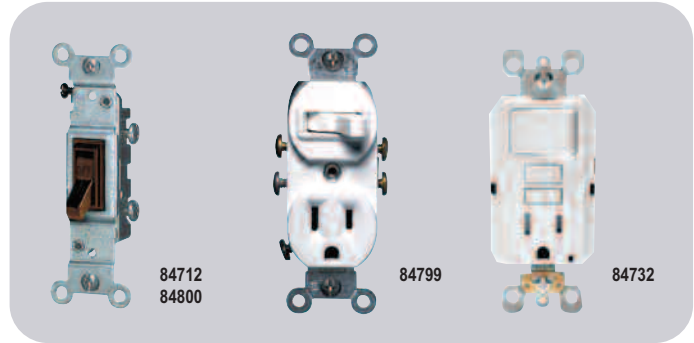

MARS NO.	DESCRIPTION	MARS PACK	CASE QTY.
84712	15a -120V, 1P, silent, brown (bulk)	10	100
84800	15a -120V, 1P, silent, ivory (bulk)	10	100
84706	15a -120/277V, 1P, silent, ivory (bulk)	10	100
84727	20a -120/277V, 1P, silent, brown (bulk)	10	100
84707	20a -120/277V, 1P, silent, ivory (bulk)	10	100
84709	20a -120/277V, 2P, silent, ivory (bulk)	10	100
84799	Combo switch/receptacle ivory (bulk) switch 15a-120/277V, 1P receptacle 15a-125V, 2P, 3W	10	100
84732	Tamper resistant smartlock pro combo switch/receptacle, white, 15a - 125V, 2P, 3W	10	100

Straight Blade Receptacles With Ground

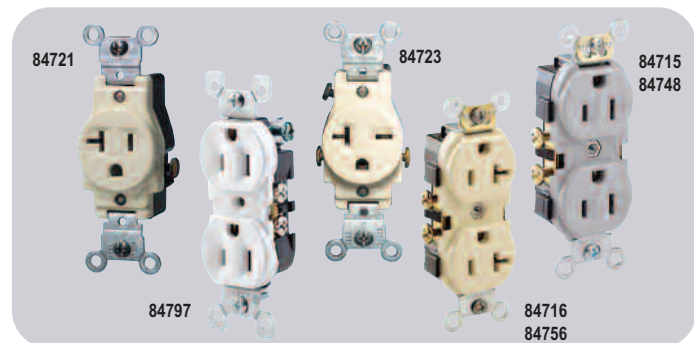

MARS NO.	DESCRIPTION	MARS PACK	CASE QTY.
84721	Single, ivory, 20a, 125V, 2P, 3W (bulk)	10	100
84723	Single, ivory, 20a, 250V, 2P, 3W (bulk)	10	100
84715	Duplex, ivory, 15a, 125V, 2P, 3W (bulk)	10	100
84748	Duplex, brn, 15a, 125V, 2P, 3W (bulk)	10	100
84797	Dup, ivory, EZ wire/screw, 15a, 125V, (bulk)	10	100
84716	Dup, ivory, 20a, 125V, 2P, 3W (bulk)	10	100

3 Pole Mini-Split Disconnect Switch

Local codes require a disconnect switch to safely shut off power for indoor mini-split AC and Heat Pumps. The disconnect switch will break both power lines L1 and L2 along with the high voltage communicating line to meet local code requirements.

- UL 30 amp rated motor disconnect
- 3 pole
- 600V max

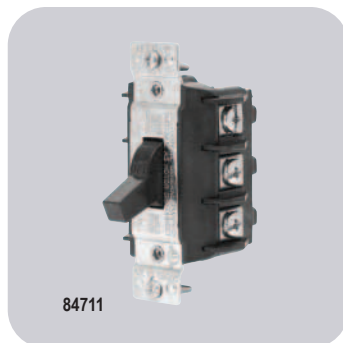

MARS NO.	DESCRIPTION	MARS PACK	CASE QTY.
84711	30A-600V 3 Pole 3Ph AC Motor Switch(Bulk)	1	100

Plugs, Connectors And Adapters

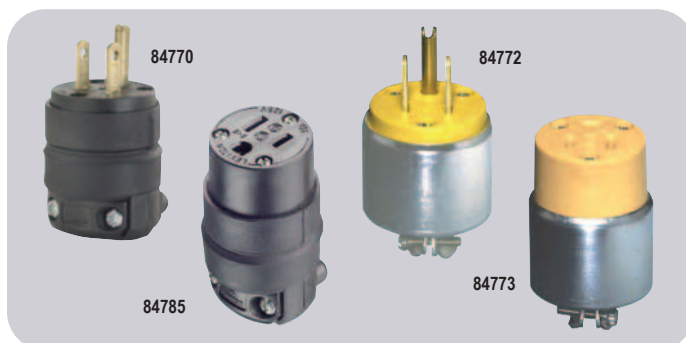

MARS NO.	DESCRIPTION	MARS PACK	CASE QTY.
84770	Grnd rubr hndl plug, 2P, 3W, 15a, 125V, black	10	100
84772	Armrd plug, 2P, 3W, 15a, 125V,	10	100
84785	Blk rubr md conn, 2P, 3W, 15a, 125V	10	100
84773	Blk armored conn, 2P, 3W, 15a, 125V	10	100

GFCI Duplex Receptacles

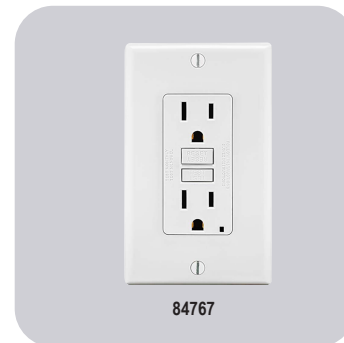

MARS NO.	DESCRIPTION	MARS PACK	CASE QTY.
84767	15a, 125V, ivory, EZ wire & screw	1	10

Wall Plates - Plastic



MARS NO.	DESCRIPTION	MARS PACK	CASE QTY.
84751	Single toggle ivory	25	250
84809	Duplex receptacle ivory	25	100

Pullchain Lampholders - White

Medium base one-piece glazed porcelain outlet box mount incandescent lampholder, single circuit, 2 screws top wired, 15A 125V outlet grounding - white



MARS NO.	DESCRIPTION	MARS PACK	CASE QTY.
84719	Porcelain lampholder w/ receptacle	1	50

Accessories

Ideal Wire Nut® Wire Connectors



IDEAL's Wire Nut® wire connectors are second to none and preferred by electricians industry wide. There are five color coded models covering every wiring combination. Some features include: positive grip design, flame retardant thermoplastic shell, longest fully seated square wire spring, threaded entry, deep skirt and wide throat entry. All Wire Nut® wire connectors are UL listed and CSA certified

Twister® wire connectors have become widely accepted due to their unsurpassed features: ribbed cap, fluted surface, compact, swept wings, hexagonal shape, tough thermoplastic shell, live action square wire spring and deep threaded skirt entry. Nutmaster™ nutdrivers can be used to install Twister® wire connectors quickly and securely. Twister® wires are UL and CSA approved.

Exceptional wire range capacity for their size, just two Twister® wire connectors handle all wire combinations. This means reduced inventories and lower costs!

Wing Nut® wire connectors were first introduced by IDEAL in 1958 and remain the most comfortable, easy to use connector on the market. The wings act as a built in wrench to provide extra leverage for secure connections...every time. Wing Nut® wire connectors handle a wide range of branch circuit and fixture wiring requirements. Just three color coded models handle UL listed wire combinations from (2) No. 18's to (1) No. 6 with (2) No. 8's, solid or stranded wire.



MARS NO.	DESCRIPTION	BOX QTY.	MFG. NO	MARS PACK	CASE QTY.
25930	Gray wire nut, 22-14 AWG	100	30-071	1	10
25931	Blue wire nut, 22-14 AWG	100	30-072	1	10
25932	Orange wire nut, 22-14 AWG	100	30-073	1	10
25933	Yellow wire nut, 18-10 AWG	100	30-074	1	10
25934	Red wire nut, 18-8 AWG	100	30-076	1	10
25936	Tan twister conn., 22-10 AWG	100	30-341	1	10
25937	Gray twister conn., 16-8 AWG	50	30-342	1	20
25938	Yellow wing nut, 18-10 AWG	100	30-451	1	10
25939	Red wing nut, 18-10 AWG	100	30-452	1	10
25940	Blue wing nut, 14-6 AWG	25	30-454	1	10

MARS Wire Connectors

MARS wire connectors are available in five color coded models: gray, blue, orange, yellow and red. Some features include a positive grip design and flame retardant thermoplastic shell. The large throat provides easy wire entrance and the deep skirt prevents shorts and grounds.



MARS NO.	DESCRIPTION	MARS PACK
25860	Gray wire connector, 300V (25/bag)	1
25880	Gray wire connector, 300V (100/bag)	1
25861	Blue wire connector, 300V (25/bag)	1
25881	Blue wire connector, 300V (100/bag)	1
25862	Orange wire connector, 600V (25/bag)	1
25882	Orange wire connector, 600V (100/bag)	1
25863	Yellow wire connector, 600V (25/bag)	1
25883	Yellow wire connector, 600V (100/bag)	1
25864	Red wire connector, 600V (25/bag)	1
25884	Red wire connector, 600V (100/bag)	1
25868	Yellow wing connector, 600V (25/bag)	1
25888	Yellow wing connector, 600V (100/bag)	1
25869	Red wing connector, 600V (25/bag)	1
25889	Red wing connector, 600V (100/bag)	1
25870	Blue wing connector, 600V (10/bag)	1
25800	Blue wing connector, 600V (50/bag)	1

Wiregard Color-Coded Screw-On Wire Connectors



MARS now offers Gardner Bender wire connectors. The industry's standard screw-on connector, with high quality, performance and durability.

- UL listed, CSA approved.
- Color-coded for easy size selection.
- Makes quick, secure connections for positive continuity. Tightens without ratcheting, removable for re-use. Fluted shell surface allows for easy fingertight connections.
- Thermoplastic shell shields against environmental extremes. Flame retardant up to 221 degrees F.
- Superior flash-over protection. High-dielectric shell features deep skirt design to prevent exposure of bare wire.
- Versatile size selection covers building wire combinations from #22 to #10 AWG.
- Complies with Federal Specification W-5-610d.



MARSNO.	MFG. NO	MODEL/SIZE	COLOR	BOX QTY.	CASE QTY.
25950	10-001	GB-1	Gray	100 Box	10
25941	10-002	GB-2	Blue	100 Box	10
25942	10-003	GB-3	Orange	100 Box	10
25943	10-004	GB-4	Yellow	100 Box	10
25944	10-006	GB-6	Red	100 Box	10

Solid Copper Wire



MARS NO.	DESCRIPTION	MARS PACK
84250	#6 Bare Solid Copper Gmrdg Wire, 25 Feet	5

Stranded Copper Building Wire, 19 Strands 10-14 Ga. THHN, 16-18 Ga. TFFN, 600V, 90°C



MARS NO.	DESCRIPTION	MARS PACK
84341	10 gauge black 500' spool	1

SJ Wire - 250 Foot Rolls



MARS NO.	DESCRIPTION	MARS PACK
84380	12/3 250 ft. reel	1
84381	14/3 250 ft. reel	1
84382	16/3 250 ft. reel	1

Mini-Split Installation Wire

Corra/Clad MC Cable consists of UL listed THHN soft drawn annealed solid copper conductors, cabled with fillers and wrapped with an overall solid Flexi-Rib aluminum sheath. The continuous sheath provides watertight protection and it is covered with a PVC outer jacket for outdoor use or direct burial. Cost effective, easy to strip and install. Meets all national codes and is suitable for outdoor use, under concrete, underground, and through interior walls and ceilings.

Compact 600 and Shielded Low Voltage Cables offer additional options to provide power and control to mini-split installations. Compact 600 uses a TPE jacket and is flexible, easy to strip, and is burial rated.

EZ-IN™ cable is an all-purpose cable that meets code for both interior and exterior use, increasing the speed of installation and making sure the job will pass inspection. EZ-IN™ Mini-Split Cable can be installed without the use of conduit and may be installed indoors and outdoors in wet locations.



MARS NO.	DESCRIPTION	DIA (IN.)	MARS PACK
----------	-------------	-----------	-----------

Compact 600 Cable: 600V, UL, UV Rated, Direct Burial

84473	14/4 Solid THHN Compact 600V – 50' Roll	0.336	1
84474	14/4 Solid THHN Compact 600V – 250' Reel	0.336	1
84479	14/4 Stranded THHN Compact 600V – 50' Roll	0.352	1
84480	14/4 Stranded THHN Compact 600V – 250' Reel	0.352	1

Shielded Low Voltage Cable: 300V, NEC 725/800, ETL, CMR/CL3R

84485	16/2 Stranded Shielded – 50' Roll	0.191	1
84484	16/2 Stranded Shielded – 250' Reel	0.191	1
84491	16/4 Stranded Shielded 300V – 50' Roll	0.212	1
84482	18/2 OAS CMR/CL3R Gy – 500'	-	1
84483	18/4 OAS CMR/CL3R Gy – 500' Reel For LG Mini-Splits	0.180	1

EZ-IN™ Cable: 600V, UL, All Purpose, UV Rated, Direct Burial

84486	14/4 Stranded EZ-IN,™ 600V, 50' Roll	0.553	1
84487	14/4 Stranded EZ-IN,™ 600V, 250' Reel	0.553	1
84494	14-4 Shielded EZ-IN,™ 600V, 250' Reel	0.553	1

Accessories

MARS 18 Gauge Thermostat Cable - ETL Listed

MARS 18 gauge thermostat wire is a class 2 power-limited circuit cable for use in thermostat control applications.

Specifications: ETL Listed type CL2. UV rated. Temp rating -20°C to +60°C. Meets UL 1581 Vertical Tray Flame Test (FT-1). Soft drawn bare copper, semi-rigid pvc insulation and PVC overall jacket.



MARS NO.	DESCRIPTION	LBS. MFT	MARS PACK
84201	18 AWG, 2 conductors, 500 ft. spool	15	4
84202	18 AWG, 3 conductors, 500 ft. spool	21	4
84203	18 AWG, 4 conductors, 250 ft. spool	27	4
84204	18 AWG, 5 conductors, 250 ft. spool	34	4
84205	18 AWG, 6 conductors, 250 ft. spool	40	4
84206	18 AWG, 7 conductors, 250 ft. spool	45	4
84207	18 AWG, 8 conductors, 250 ft. spool	51	4
84209	18 AWG, 10 conductors, 250 ft. spool	63	4

MARS 20 Gauge Thermostat Cable - UL Listed

MARS 20 gauge thermostat wire is a class 2 power-limited circuit cable for use in thermostat control applications.

Specifications: UL type CL2. UV rated. Temp rating -20°C to +60°C. Soft drawn bare copper, semi-rigid pvc insulation and PVC overall jacket.



MARS NO.	DESCRIPTION	LBS. MFT	MARS PACK
84211	20 AWG, 2 conductors, 500 ft. spool	11	4
84213	20 AWG, 4 conductors, 250 ft. spool	18	4
84214	20 AWG, 5 conductors, 250 ft. spool	22	4
84215	20 AWG, 6 conductors, 250 ft. spool	26	4
84217	20 AWG, 8 conductors, 250 ft. spool	33	4

Shielded Plenum T-Stat Wire - UL Listed - Type CL2P-Stranded



MARS NO.	DESCRIPTION	LBS. MFT	MARS PACK
84461	18 AWG, 2 conductors, 500 ft spool	17	4

18 Ga ETL Listed Thermostat Wire - Self Dispensing Coils

MARS thermostat wire is now available in self dispensing coil packs. These shrink wrapped coils are easier to use and more convenient to store than the traditional thermostat wire sold on spools/reels.



Features & benefits:

- Heavy duty shrink wrapped coils for durability
- No reels to bend, break, or rust
- Compact coils are easier to store – takes up less space
- Easier to handle
- Stacks better
- Easy and convenient to use

How to use:

- Simply punch hole in center of wrap (Do not remove wrap)
- Pull loose end of wire from center (Wire will pull out easily)
- Snip off the required amount of wire
- Tuck loose end back into the coil for storage

MARS NO.	DESCRIPTION	MARS PACK
84401	18/2 500 ft. Coils	4
84402	18/3 500 ft. Coils	4
84403	18/4 250 ft. Coils	4
84404	18/5 250 ft. Coils	4
84405	18/6 250 ft. Coils	4
84406	18/7 250 ft. Coils	4
84407	18/8 250 ft. Coils	4

Plenum T-Stat Wire - Solid ETL Listed

- Temp rating (-20°C to 75°C)
- ETL Listed, CL2P
- Thermoplastic jacket (2500 PSI min)
- Thermoplastic insulation (2000 PSI min)
- Can be used in overhead plenum area without conduit



MARS NO.	DESCRIPTION	MARS PACK
84241	18 AWG, 2 conductors, 500 ft. spool	4
84242	18 AWG, 3 conductors, 500 ft. spool	4
84243	18 AWG, 4 conductors, 250 ft. spool	4
84244	18 AWG, 5 conductors, 250 ft. spool	4
84245	18 AWG, 6 conductors, 250 ft. spool	4

Hand Wire Caddy

Rugged Construction, epoxy coated to reduce chipping & peeling

Holds up to 8 reels, 7" D x 5" W, or 4 reels 7" D x 6" to 10" W

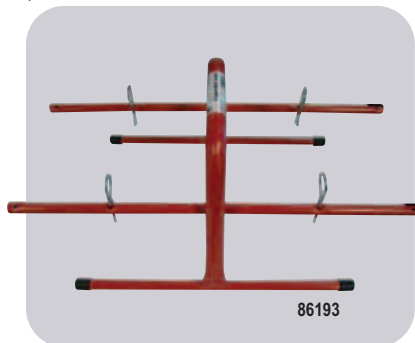

MARS NO.	DESCRIPTION	MARS PACK
86193	Wire Hand Caddy, 22-1/2" L x 13-1/2" W x 9-1/2" H	1

LED Omnidirectional Shatterproof Bulbs

These LED bulbs are ideal for both residential and commercial settings. Dimmable down to 10% for additional energy savings and ambiance control.

Features:

- 85% energy savings compared to incandescent lamps
- RoHS compliant and mercury free

Specifications:

- Input Voltage: 120V
- Average Rated Life: 25,000 Hours
- CRI: 80
- Beam Angle: 220°
- Ambient temp: -4°F to 104°F



MARS NO.	DESCRIPTION	WATTS	EQUIVALENT WATTS	BASE	INITIAL LUMENS	PACK QTY
79243	LED Shatterproof Bulb	11	75	E26 - Medium Base	1100	6
79244	LED Shatterproof Bulb	15	100	E26 - Medium Base	1600	6

Adhesive Wire Markers

Wire marker dispenser measures 3" x 6" and holds 10 tape rolls at once. Rugged, sturdy case fits in your pocket. Durable long lasting tapes are excellent for wire, pipe and conduit identification.

Wire marker booklets contain 10 pages each. Plastic impregnated cloth marker resists abrasion, moisture, dirt and oil. Markers are 1-1/2" in length and can be separated into half-length sizes.



MARS NO.	DESCRIPTION	MFG. NO	MARS PACK	CASE QTY.
25920	Wire marker dispenser, 0-9 legends	42-301	1	5
25921	Wire marker book, 0-9 legends	44-101	5	5
25922	Wire marker book, A-Z legends	44-102	5	5
25923	Wire marker book, 1-45 legends	44-103	5	5

Square Steel Boxes



MARS NO.	DESCRIPTION	MARS PACK	CASE QTY.
84936	4", 2-1/2" D 1/2" & 3/4" K.O.	1	25
84937	4", 1-1/2" D 1/2" K.O.	1	25
84938	4", 1-1/2" D 1/2" & 3/4" K.O.	1	25
84943	4-11/16", 2-1/8" D 1/2" & 3/4" K.O.	1	25

Accessories

2-1/8" x 4" Steel Utility Boxes



84947
84948
84949
84950

MARS NO.	DESCRIPTION	MARS PACK	CASE QTY.
84947	1-1/2" D 1/2" K.O.	1	25
84948	1-7/8" D 1/2" K.O.	1	25
84949	2-1/8" D 1/2" K.O.	1	25

Steel Extension Rings

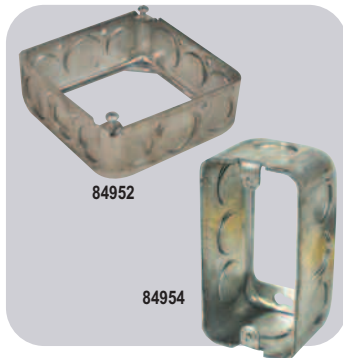

84952

84954

MARS NO.	DESCRIPTION	MARS PACK	CASE QTY.
84952	1-1/2" D 1/2" & 3/4" K.O. (4" sq.)	1	25

Square Steel Covers

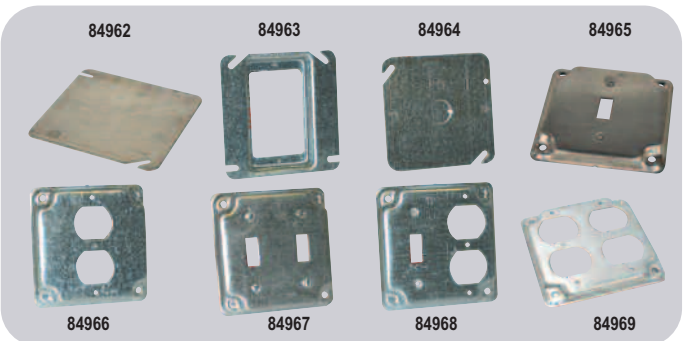

84962

84963

84964

84965

84966

84967

84968

84969

MARS NO.	DESCRIPTION	MARS PACK	CASE QTY.
84962	4", flat blank	1	25
84963	4", 1/2" depth, single flush	1	25
84964	4", flat, 1/2" K.O. in center	1	25
84965	4", 1/2" raised, single toggle switch	1	25
84966	4", 1/2" raised, 1 duplex receptacle	1	25
84968	4", 1/2" raised, 1 toggle sw. & 1 dup. recept.	1	25
84969	4", 1/2" raised, 2 duplex receptacle	1	25

2-1/8" x 4" Steel Utility Box Covers



84987

84988

84989

84990

84991

MARS NO.	DESCRIPTION	MARS PACK	CASE QTY.
84987	Duplex receptacle	1	25
84988	Toggle switch	1	25
84989	Blank	1	25
84990	Blank with 1/2" K.O. in center	1	25
84991	Single receptacle	1	25

One Gang - Weatherproof Outlet Boxes

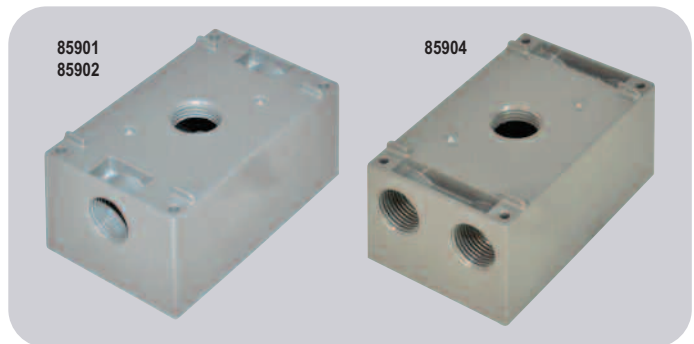

85901
85902

85904

MARS NO.	DESCRIPTION	MARS PACK	CASE QTY.
85901	Three 1/2" holes with lugs	1	50
85902	Three 3/4" holes with lugs	1	50
85904	Five 1/2" holes with lugs	1	50

Two Gang - Weatherproof Outlet Boxes

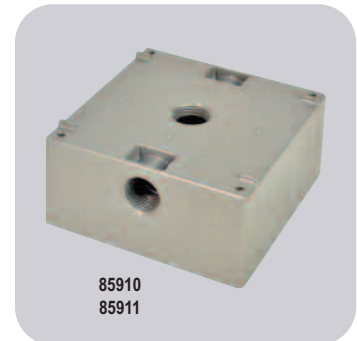

85910
85911

MARS NO.	DESCRIPTION	MARS PACK	CASE QTY.
85910	Three 1/2" holes with lugs	1	10
85911	Three 3/4" holes with lugs	1	10

Self Closing GFCI Weatherproof Covers

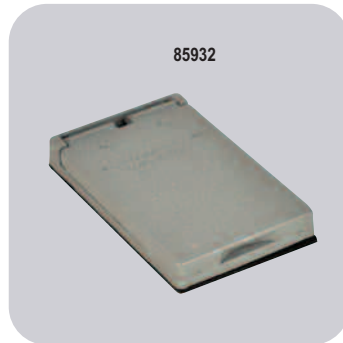

MARS NO.	DESCRIPTION	MARS PACK	CASE QTY.
85932	One gang for vertical devices	1	10

Weatherproof Blank Covers

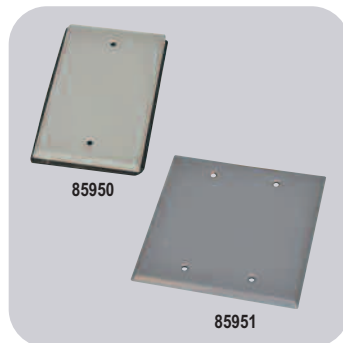

MARS NO.	DESCRIPTION	MARS PACK	CASE QTY.
85950	One gang for vertical devices	1	25
85951	Two gang with gasket and screws	1	10

4" Octagon Steel Covers



MARS NO.	DESCRIPTION	MARS PACK	CASE QTY.
84980	Flat blank	1	25

Electrical Fittings-EMT Type-Carded

• Zinc die cast construction



MARS NO.	DESCRIPTION	CASE QTY.
85115	1/2" EMT set screw connector, bulk	50
85326	3/4" EMT set screw connector, bulk	25
85327	1/2" EMT set screw coupling, bulk	50
85329	1/2" EMT compression connector, bulk	50
85330	3/4" EMT compression connector, bulk	25
85332	1/2" EMT compression coupling, bulk	50
85335	1/2" EMT one-hole strap, 5/bag	-
85336	3/4" EMT one-hole strap, 4/bag	-
85302	3/4" EMT one-hole strap, bulk	100
85337	1" EMT one-hole strap, 2/bag	-
85338	1 1/4" EMT one hole strap, 4/bag	-
85306	1/2" rigid IMC strap, bulk	50
85307	3/4" rigid IMC strap, bulk	50
85308	1" rigid IMC strap, bulk	25

Electrical Fittings-Rigid Conduit-Carded



MARS NO.	DESCRIPTION	CASE QTY.
85364	3/4" x 1/2" reducing washer, 4/cd	10
85279	1 1/4" x 3/4" reducing washer, bulk	50
85280	1 1/4" x 1" reducing washer, bulk	50
85281	1 1/2" x 1/2" reducing washer, bulk	50
85282	1 1/2" x 3/4" reducing washer, bulk	50
85374	1/2" - 1" ground clamps, 1/cd	10

Accessories

Electrical Fittings- BX/Romex/Armored-Carded

- Zinc die cast construction



MARS NO.	DESCRIPTION	CASE QTY.
85402	3/8" arm./flex. 90° squeeze conn, bulk	50
85155	1/2" arm./flex. 90° squeeze conn, bulk	25
85156	3/4" arm./flex. 90° squeeze conn, bulk	10
85175	3/8" arm./flex. duplex connector, bulk	25
85396	3/8" BX/MC/Romex connector, 3/cd	10
85403	3/8" BX/MC/Romex connector, bulk	100
85397	3/8" Romex squeeze connector, 4/cd	10
85185	3/8" Romex squeeze connector, bulk	100
85398	3/4" Romex squeeze connector, 2/cd	10
85186	3/4" Romex squeeze connector, bulk	25
85399	1" Romex squeeze connector, 2/bag	20
85187	1 1/2" Romex squeeze connector, bulk	50

Liquid-Tight Metallic Fittings

- Zinc die cast construction
- Complete conduit/connector system is reusable
- Suitable for indoor/outdoor use



MARS NO.	DESCRIPTION	MARS PACK	CASE QTY.
85001	1/2" straight metallic connector	20	250
85002	3/4" straight metallic connector	10	100
85005	1/2" 90° metallic connector	10	100
85006	3/4" 90° metallic connector	10	100

Liquid-Tight PVC Non-Metallic Fittings

- Molded of type nylon 6, resists salt water, weak acids, gasoline, alcohol, oil, grease, and common solvents
- Complete conduit/connector system is reusable
- Suitable for indoor/outdoor use

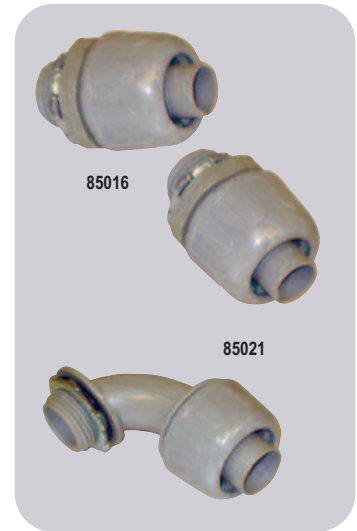

MARS NO.	DESCRIPTION	MARS PACK	CASE QTY.
85015	3/8" straight non-metallic connector	25	250
85016	1/2" straight non-metallic connector	25	250
85017	3/4" straight non-metallic connector	10	100
85018	1" straight non-metallic connector	5	50
85019	3/8" 90° non-metallic connector	10	100
85020	1/2" 90° non-metallic connector	10	100
85021	3/4" 90° non-metallic connector	10	100
85022	1" 90° non-metallic connector	5	50

Liquid-Tight Screw On Connectors

This attractive one pc design allows superior liquid-tight seal & Optimum pull strength without compression nut. PVC construction produced from UV rated material for long outdoor life. Ideal for conduit assemblies & installers. "O" ring & steel locknut included.



MARS NO.	DESCRIPTION	MARS PACK	CASE QTY.
84992	1/2" Straight Screw On	25	100
84993	3/4" Straight Screw On	25	100
84994	1/2" 90 Deg Sweep Screw On	10	100
84995	3/4" 90 Deg Sweep Screw On	10	100

Liquid-Tight Metal Screw on Connectors

- Suitable for indoor/outdoor use



MARS NO.	DESCRIPTION	MARS PACK
85026	Liquid Tight Connector Straight	25
85027	Liquid Tight Connector 90° Angle	15

MARS Major Appliance Extension Cords, UL Listed



MARS NO.	DESCRIPTION	CASE QTY.
84625	15a-125V, 14/3 spt, 3 foot appliance ext.	30
84627	15a-125V, 14/3 spt, 9 foot appliance ext.	15
84633	20a-250V, 12/3 spt, 6 foot appliance ext., gray	25

MARS Range And Dryer Receptacles

- 3 Pole, 3W & 4W surface mounting receptacles



MARS NO.	DESCRIPTION	CASE QTY.
84700	30a-250V, surface mount dryer receptacle	10
84701	30a-250V, flush mount dryer receptacle	25
84702	50a-250V, surface mount range receptacle	10
84699	30a-250V, srfc. mnt. dryer recept., 3P4W, ground	10
84705	50a-250V, srfc. mnt. range recept., 3P4W, ground	10

MARS Pigtails/Replacement Cords - 13 Amp, 125V & 250V



MARS NO.	DESCRIPTION	CASE QTY.
84668	12/3 pigtail 6 ft. SPT-3 RT 250V	50
84670	16/3 pigtail 6 ft. SPT-3 RT 125V	50
84671	16/3 pigtail 8 ft. SPT-3 RT 125V	50
84673	16/3 pigtail 3 ft. SPT-3 STR 125V	50
84674	16/3 pigtail 6 ft. SPT-3 STR 125V	50
84679	16/3 pigtail 6 ft. SPT-BL STR 125V	50
84681	14/3 pigtail 6 ft. SPT-BL STR 125V	50
84682	14/3 pigtail 9 ft. SPT-BL STR 125V	50

Accessories

Power Block Type Extension Cords, 15a-125V - UL listed



MARS NO.	DESCRIPTION	CASE QTY.
84649	Power block ext. 12/3 sjtwa, 2 foot	4

Outdoor Heavy Duty Ext. Cords, UL Listed - SJTWA



MARS NO.	DESCRIPTION	CASE QTY.
84652	Outdoor ext. 16/3, 13a-125V, 25 foot, orange	24
84653	Outdoor ext. 14/3, 15a-125V, 25 foot, red	14
84655	Outdoor ext. 16/3, 13a-125V, 50 foot, orange	12
84656	Outdoor ext. 14/3, 15a-125V, 50 foot, red	10
84657	Outdoor ext. 12/3, 15a-125V, 50 foot, yellow	6
84658	Outdoor ext. 16/3, 10a-125V, 100 foot, orange	6
84659	Outdoor ext. 14/3, 13a-125V, 100 foot, red	6

Trouble Lights, One Grounded Outlet - UL Listed



MARS NO.	DESCRIPTION	CASE QTY.
84696	Metal cage trouble light, 16/3, SJT, 13a, 25'	8
84697	Metal cage trouble light, 16/3, SJT, 13a, 50'	6

Portable Lighting



MARS NO.	DESCRIPTION	CASE QTY.
84689	8-1/2" clamp light - 6 ft cord	6

Polypropylene Web Duct Strap

- Designed for hanging of flexible duct
- Made of high tensile strength - 400 lbs. min up to 460 lbs. max
- Abrasion and chemical resistant
- Easy to cut and staple to joists
- UL 723 Flame and Smoke

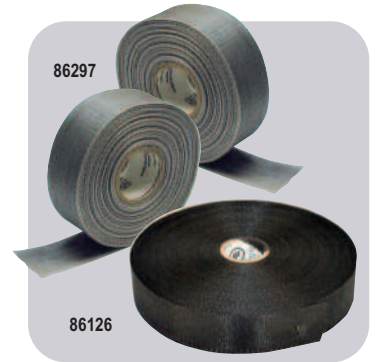

MARS NO.	DESCRIPTION	MARS PACK
86126	Black 1 3/4" x 100 yds.	24
86296	Black 3" x 100 yds	8
86297	Silver 1-3/4" x 100 yds	24
86298	Silver 3" x 100 yds	8

Truck And Equipment Tarps

MARS equipment tarps provide a durable blue protective covering for truck beds, construction material and contractors tools.

- Rust-proof aluminum grommets
- All edges heat-sealed and reinforced with woven polyethylene yarn for durability
- Waterproof and UV resistant

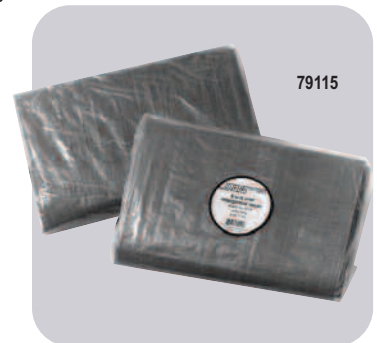

MARS NO.	DESCRIPTION	MARS PACK	CASE QTY.
79115	8' x 10' blue tarp	1	20
79116	12' x 12' blue tarp	1	12

Molded Rubber Straps

Molded rubber straps are made of high quality black rubber. Sturdy hooks will not loosen.



MARS NO.	DESCRIPTION	MARS PACK
79592	24" length - bulk	24
79593	35" length - bulk	24

Truck Rope-Polypropylene - USA

MARS truck rope is made of a polypropylene construction. All ropes are made in the USA. Applications range from hoisting, truck bed material tie down, job site tie off and a wide variety of other uses. MARS #79059 and #79060 include handy safety hook.



MARS NO.	DESCRIPTION	MARS PACK	CASE QTY.
79053	3/8" x 50' yellow	1	12
79055	3/8" x 50' blk/orange	1	12
79056	3/8" x 100' blk/orange	1	12
79057	1/2" x 50' blk/orange	1	12
79059	3/8" x 50' blk/orange with safety hook	1	12
79060	1/2" x 50' blk/orange with safety hook	1	12

Galvanized Duct Straps

The perforated, galvanized duct strap has 1/4" and 9/64" holes for nails & bolts.

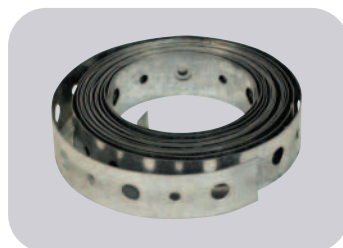

MARS NO.	DESCRIPTION	MARS PACK	CASE QTY.
86025	28 gauge 3/4" x 10' RL bulk	100	100
86026	28 gauge 3/4" x 50' RL boxed	1	1
86027	28 gauge 3/4" x 100' RL boxed	1	1
86032	20 gauge 3/4" x 25' RL boxed	6	6
86033	20 gauge 3/4" x 50' RL boxed	1	1

Pipe Hangers

The DWV pipe hangers are designed for rapid installation of both ABS and PVC plastic DWV piping with standard flat head galvanized nails. Galvanized steel construction. The pipe hanger is the fastest way to install round 5", 6" or 7" heating pipes below the joist. No nails needed.



MARS NO.	DESCRIPTION	MARS PACK	CASE QTY.
86040	DWV pipe hanger 2" x 12"	50	50
86041	DWV pipe hanger 3" x 12"	50	50

Mechanics Hanging Wire

MARS No. 84418 Plasta-Reel conveniently unwinds and hangs over post or peg on truck bed, from a 2 x 4 or nail. Prevents tangling. This polyethylene reel is smooth and safe to handle. Never blisters, burns or cuts the skin as metal might do! 825 ft. per roll.

MARS No. 84419 is 18 gauge galvanized wire annealed to ensure the wire can be tied/bent with ease. The wire is packaged in spools, easy to work with.



MARS NO.	DESCRIPTION	MARS PACK	CASE QTY.
84418	18 gauge Black Ann 5 lbs.	50	500
84419	18 gauge Galvanized 5 lbs.	50	500

Accessories

MARS Wire Ties, 100 Packs

MARS nylon wire ties and duct straps are available in a wide variety of styles, color and tensile strengths. They range in sizes from 4" to 36" with tensile strengths from 18 lbs. to 175 lbs. All MARS wire ties and duct straps feature the bent tip design for ease and insertion.



MARS NO.	DESCRIPTION				MARS PACK
86100	4"	natural	standard	3/4" dia. x 18 lbs.	1
86101	4"	black	standard	3/4" dia. x 18 lbs.	1
86104	5.5"	natural	standard	1 1/4" dia. x 40 lbs.	1
86105	5.5"	black	standard	1 1/4" dia. x 40 lbs.	1
86106	8"	natural	standard	1 3/4" dia. x 40 lbs.	1
86107	8"	black	standard	1 3/4" dia. x 40 lbs.	1
86108	11"	natural	standard	3" dia. x 50 lbs.	1
86109	11"	black	standard	3" dia. x 50 lbs.	1
86153	14"	black	standard	4" dia. x 120 lbs.	1
86110	14.5"	natural	standard	4" dia. x 50 lbs.	1
86111	14.5"	black	standard	4" dia. x 50 lbs.	1
86112	6"	natural	screw mount	1 1/4" dia. x 30 lbs.	1
86113	6"	black	screw mount	1 1/4" dia. x 30 lbs.	1
86114	7.5"	natural	screw mount	1 3/4" dia. x 50 lbs.	1
86115	7.5"	black	screw mount	1 3/4" dia. x 50 lbs.	1
86155	11"	black	screw mount	3" dia. x 50 lbs.	1
86156	14"	black	screw mount	4" dia. x 50 lbs.	1
86157	14"	natural	screw mount	4" dia. x 50 lbs.	1

MARS Wire Ties, Bulk Packs

MARS NO.	DESCRIPTION				MARS PACK
86116	8"	natural	standard	1 3/4" dia. x 40 lbs.	(1000 pk) 1
86117	8"	black	standard	1 3/4" dia. x 40 lbs.	(1000 pk) 1
86118	11"	natural	standard	3" dia. x 50 lbs.	(500 pk) 1
86119	11"	black	standard	3" dia. x 50 lbs.	(500 pk) 1

MARS Duct Straps, 175 lbs., 50 Packs

MARS NO.	DESCRIPTION				MARS PACK
86127	24" duct strap for up to	6" duct	natural		1
86128	36" duct strap for up to	10" duct	natural		1
86129	48" duct strap for up to	14" duct	natural		1
86102	24" duct strap for up to	6" duct	black		1
86103	36" duct strap for up to	10" duct	black		1

Ready Utility Knife

Ready

- Featuring the QUICKEST blade change in the industry.
 - Rugged all steel construction
 - Folds to a very compact size
 - Easily and quickly change blades with the push of a button
 - Set includes knife, nylon carrying case, and 5 standard blades.
- Standard Blade Dimensions: 2.4" L x 1.25" W x 0.75" H, 0.6mm thickness



MARS NO.	DESCRIPTION	MARS PACK	CASE QTY.
25784	Utility knife	1	48

MARS Knife Sharpener

Finally, a Knife Sharpener anyone can use! No more messy oils or stones. Sharpen knives in about 10 seconds (even serrated knives), cleavers, axes, machetes, and many other cutting tools. The full length finger guard protects your fingers. Sharpening blades are Diamond Honed Tungsten Carbide for years of reliable use. AccuSharp Knife Sharpeners will not rust and can be cleaned with soap and water or in the dishwasher.



MARS NO.	DESCRIPTION	CASE QTY.
27520	MARS Knife Sharpener	12

Cable Tie Tool

Cable Tie Tools are economical, lightweight and easy to use. Ideal for heavy duty ties and duct straps. Constructed from high grade steel.

- Heavy duty construction
- Installer controls tensioning
- Squeeze to cut excess
- Cuts up to 60" 175 lbs. cable ties



MARS NO.	DESCRIPTION	COLOR	BAG	CASE QTY.
25683	Cable tie tool	Red	1	100

Braze-On Service Valves - Saddle Valves

Braze-on self-piercing copper service valves are widely used and easily installed on a charged line. After brazing the saddle portion onto the line, the steel pin with valve core penetrates the line and is locked into place simply by tightening the cap. Available in sizes from 1/4" to 1-1/8".



MARS NO.	DESCRIPTION	MARS PACK
65425	1/4" qty 6 per bag	1
65426	5/16" qty 6 per bag	1
65427	3/8" qty 6 per bag	1
65428	1/2" qty 4 per bag	1
65430	3/4" qty 2 per bag	1
65431	7/8" qty 2 per bag	1

Economy Line Service Valves - Extended Copper Tubes

- With valve core & flat cap (#65408)
- 1/4" male flare access fitting

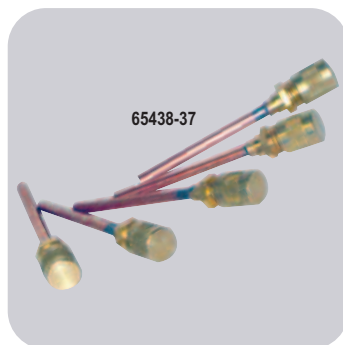

MARS NO.	DESCRIPTION	MARS PACK
65438	3/16" copper tube extension, qty. 6 / bag	1
65439	1/4" copper tube extension, qty. 6 / bag	1
65440	5/16" copper tube extension, qty. 6 / bag	1
65441	3/8" copper tube extension, qty. 6 / bag	1
65442	1/8" copper tube extension, qty. 6 / bag	1
65435	3/8" copper tube extension, bulk	100
65436	3/16" copper tube extension, bulk	50
65437	1/4" copper tube extension, bulk	50

Copper Tees - 1/4" Male Flare

Copper tees have bodies brazed on. Using copper for the tee portion allows tubing to be attached to each end and allows using a solderless than silver solder, such as 95-5. They are to be used where two line ends have not yet been attached or where it is desirable to cut a line rather than drive a hole on an uncharged system. Copper tees save time and money.

- Includes valve core and flat cap (#65408).



MARS NO.	DESCRIPTION	MARS PACK
65447	Tee for 1/4" O.D. tube (2 bag)	1
65448	Tee for 5/16" O.D. tube (2 bag)	1
65449	Tee for 3/8" O.D. tube (2 bag)	1
65450	Tee for 1/2" O.D. tube (2 bag)	1
65451	Tee for 5/8" O.D. tube (2 bag)	1
65452	Tee for 3/4" O.D. tube (2 bag)	1
65453	Tee for 7/8" O.D. tube (2 bag)	1

Tees Connectors

Tee connectors are used to connect controls to check oil pressure on larger compressors having positive pressure oil pumps and to check the accuracy of oil pressure gauges installed on the equipment by the manufacturer against your gauge with known accuracy.



MARS NO.	DESCRIPTION	MARS PACK
65459	1/4" m. flare x 1/4" f. flare nut w/ depressor tip x 1/4" m. flare on the branch w/one valve core (qty. 2 per bag)	1
65460	1/4" m. flare with valve core x 1/4" m. flare x 1/4" f. flare nut w/ depressor tip on the branch (qty. 2 per bag)	1
65461	All brass tee connector 1/4" m. flare with valve core & cap x 1/4" m. flare x 1/4" f. flare nut with depressor tip on branch (qty. 1 per bag)	1

Accessories

Brass Bodies - Half Unions

MARS brass bodies have a 1/4" standard male flare above the hex. Below the hex are various threads, outside diameters and inside diameters for accepting different sizes of tubing and connections. A flat top brass cap and valve core are included.



MARS NO.	DESCRIPTION	MARS PACK
65401	1/4" MPT dry seal x 1/4" male flare 5/16" I.D. hole accommodates 5/16" O.D. tube. Qty. 2 per bag	1
65402	1/8" MPT dry seal x 1/4" male flare 1/4" I.D. hole accommodates 1/4" O.D. tube. Qty. 6 per bag	1
65403	1/4" male flare for 1/8" I.D. hole - accommodates 1/8" O.D. tube. (3/16", 1/4", 5/16" O.D. steps) Qty 6 per bag	1

Brass Caps & Valve Cores

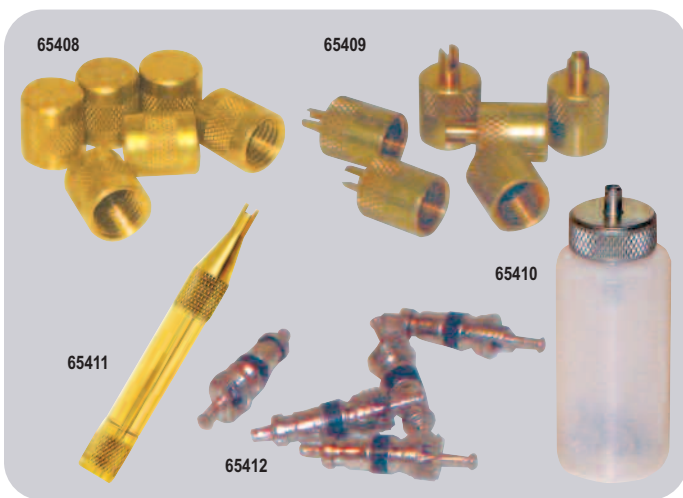

MARS NO.	DESCRIPTION	MARS PACK
65408	Round brass flat cap w/neoprene O-ring seal for 1/4" flare, qty 6 per bag	1
65409	Round brass cap w/ core wrench top and neoprene O-ring seal for 1/4" flare, qty 6 per bag	1
65410	Plastic core container - includes six valve cores and a core wrench and thread chaser	1
65411	Brass core remover container with wrench tip - includes three valve cores	1
65412	Valve core w/seal, qty. 6 per bag	1

Core Removal Tools With Ball Valve

MARS core removal tools are used to remove and replace valve cores in a 1/4" flare without losing refrigerant. Because it has a ball valve inside rather than a stem-type valve, the tool can be closed with just a quarter turn. This convenient compact size tool is ideal for working in close quarters.

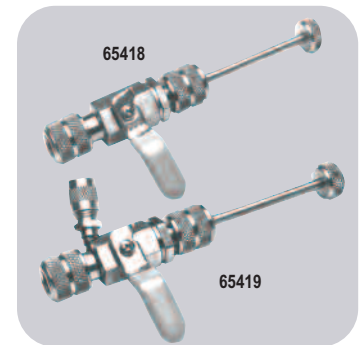

MARS NO.	DESCRIPTION	MARS PACK
65418	Core removal tool	1
65419	Core removal tool w/ 1/4" male flare side port	1

MARS Universal Refrigerant Locking Caps

Made in USA



MARS Universal Refrigerant Locking Caps meet or exceed local and national code requirements to prevent unauthorized refrigerant theft. Effective February 2009, the **International Mechanical Code 1101.10** and the **International Residential Code M1411.6** now require that all outdoor access ports on A/C Refrigerant circuits be made tamper resistant.

Features:

- Heavy duty brass construction
- Corrosion resistant
- Water/dust proof sleeve
- Exceeds local and national code requirements
- Protects against: refrigerant theft

Kit Includes:

- Locking cap key
- 10 Locking caps (1/4")
- 10 Waterproof sleeves
- 5 Warning labels



MARS NO.	DESCRIPTION	MARS PACK
65420	Universal Locking Caps, Blk, Qty. 10	1



Chemicals

Thawzone liquid dehydrant chemically "dries" all refrigerants (R12, R22, R134, etc.), methyl chloride, and methylene chloride. Thawzone frees frozen systems due to moisture in five minutes. It prevents refreezing, does not leave any residue, does not contain any dissolved solids or methanol, and works with or without solid dryers. Available in 1 oz., 4 oz. and 16 oz. plastic bottles.

Leak Lock joint sealer is a soft setting pipe joint compound for sealing threaded joints, flanged joints, gasket surfaces and mating surfaces. This resin based brushable paste remains permanently flexible, adheres to internal surfaces and fills voids. It is ideal for use on metal and plastic materials subject to extreme vibrations, temperatures from -100°F (-73°C) to 400°F (204°C) full vacuums to 10,000 PSI. Leak Lock seals all refrigerants (R12, R22, R502, R134A, etc.) petroleum products, natural and manufactured gases, steam, water, air, etc. Available in 1 1/3 oz. plastic tube and 4 oz. and 1 pint brush top plastic jars.

Red Epoxy aluminum sealer is a high performance heat cured, two part epoxy kit for patching or sealing on all metals and some plastics. Red Epoxy is cured within minutes and equipment is serviceable immediately. It is excellent for sealing threaded or unthreaded pipes and is great as a field repair kit for aluminum evaporators, coils, radiators, pipes, tanks, etc. Temperature range: -100°F (-73°C) to 300°F (149°C). Tensile strength: 600 PSI. working pressure tested in excess of 3000 PSI. Kit includes resin & hardener. (.5 oz. tube each)

Low-Temp Gas Leak Detector is non-toxic and non-hazardous and does not contain ethylene glycol. This non-freezing, viscous florescent, bubble type gas leak detector is rated to -30°F (-34°C). The leaks appear as large strong bubbles which cling to the applied surface and are florescent under a black light. For use on hot and cold piping and equipment containing most gases such as air, natural gas, all refrigerants (R12, R134A, R22, R502, etc.) ammonia, SO₂ etc.

The mid-temp gas leak detector is non-toxic and non-hazardous. It is a viscous, florescent, bubble-type gas leak detector rated to 27°F (-3°C). Leaks appear as large strong bubbles which cling to the applied surface and are florescent under a black light. For use on hot and cold piping equipment containing most gases such as air, natural gas, all refrigerants (R12, R134A, R22, R502A, etc.), ammonia, SO₂ etc.

Solderlene is a high quality, paste type, non-acid soldering flux with industrial strength wetting agents to promote solder flow. For use with all low and mid temperature soft solders, both lead bearing and lead-free, on all metals except aluminum and magnesium.

Trace is a red dye trace type internal leak detector for use with mineral oil base refrigerant lubricants and hydraulic systems. Leaks show as intense red stains Trace is non-volatile, will not sludge oil or deposit gum. Trace is soluble in the lubricant and liquid refrigerant but not the gas and travels with the lubricant. Oil separators will remove trace and should be bypassed. Trace passes through solid core dryers but the color intensity may be reduced.



MARS NO.	DESCRIPTION	MARS PACK
93801	Thawzone 1 oz. bottle	24
93802	Thawzone 4 oz. bottle	12
93803	Leak Lock 1 1/3 oz. tube	24
93804	Leak Lock 4 oz. brush top jar	12
93805	Leak Lock 1 pint brush top jar	12
93806	Red Epoxy kit .5 oz. tube	24
93807	Low Temp Gas Detector 8 oz. dauber bottle	24
93809	Mid-temp gas detector 8 oz. dauber bottle	24
93810	Mid-temp gas detector 32 oz. trigger spray	12
93811	Screwloose® Solderlene 4 oz. brush top jar	24
93812	Solderlene 1 pint brush top jar	12
93813	Trace® 4 oz. bottle	12
93814	Trace® 16 oz. bottle	6

MARS Liquid Line Filter Driers

The MARS Liquid Line Filter Driers are designed to offer complete protection of your refrigerant system. The desiccant block is a carefully selected blend of molecular sieve and activated alumina, providing for maximum removal of moisture, acid, and foreign materials. This molded desiccant block allows for efficient filtration and retention of solid contaminants, while insuring minimum pressure drop. The solid molded block exposes maximum surface area and provides even distribution of filtered material as the refrigerant flows through the drier. These driers are intended for use on R-134A, R-404A, R-410A, R-507, R-12, R-500, R-502

Features & Benefits:

- High moisture removal
- High organic & inorganic acid removal
- Solid block desiccant core
- For use with HCFCs, CFCs, and the lubricants that go with them
- Nickel plated SAE flare and solid copper ODF fittings
- Corrosion resistant
- Maximum working pressure 600 PSIG
- Minimum burst pressure 2500 PSIG
- UL & CSA listed

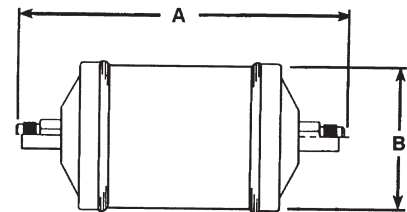

MARS NO.	MODEL NO	CONNECTIONS SIZE & TYPE	DIMENSIONS		FLOW CAPACITY ¹ TONS @ 1 PSI			CASE QTY.
			A	B	R-134A	R-22/R410A	R404A/R507	
20114	MLD-083	3/8 SAE	6.10	2.50	4.9	4.7	3.0	12
20115	MLD-083S	3/8 ODF	5.43	2.50	6.2	5.9	3.9	12

¹ All ratings in accordance with ARI standard 710-04, 86°F Liquid Refrigerant Temperature, 5°F Saturated Temperature 4.0 lbs./min./ton for R-134a, 2.9 lbs./min./ton for R-22, 4.0 lbs./min./ton for R-404A/R-507

MARS suction line driers - flow capacities¹ in refrigerant tons at selected evaporator temps

The MARS Suction Line Filter Driers are designed to effectively clean up the refrigerant system by removing solid contaminants and harmful acids that were created during a motor burnout. As well as motor burnout applications, the MARS Suction Line Drier should be installed in remote systems with long refrigerant lines. The filter drier will collect and hold any dirt that is in the evaporator or suction line at start up. Any field built-up system requires the protection that the MARS Suction Line Drier offers.

The desiccant block core effectively removes and holds a maximum amount of contaminants with minimum pressure drop. The binding material in the core protects the core from acid decomposition and allows it to collect and hold organic and inorganic acids from motor burnout. An inlet deflector spreads the refrigerant flow evenly across the molded core to provide full filtration capacity and to prevent erosion of the core.

Features & Benefits:

- For use on R134A, R12, R22, R500, R404A, R410A, R507
- Dual access valve for accurate pressure drop readings
- Solid block desiccant core
- High organic & inorganic acid removal
- For use with HCFCs, CFCs and the lubricants that go with them
- Nickel plated SAE flare and solid copper ODF fittings
- Corrosion resistant paint
- Maximum working pressure 600 PSIG
- Minimum burst pressure 2500 PSIG
- UL & CSA listed

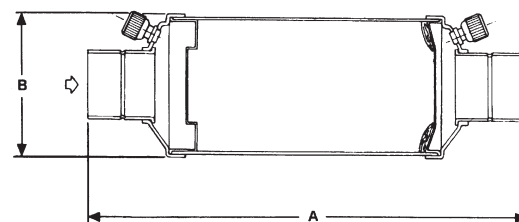
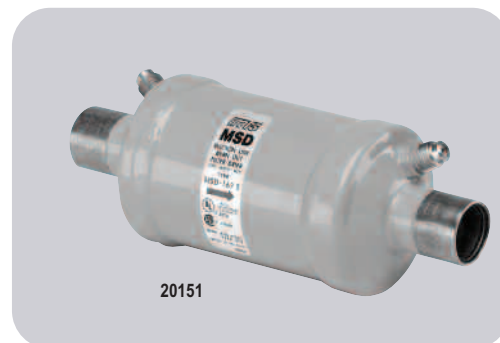

MARS NO.	+40°F	+20°F	0°F	-20°F	+40°F	+20°F	0°F	-20°F	-40°F	+40°F	+20°F	0°F	-20°F	-40°F	+40°F	+20°F	0°F	-20°F	-40°F
	R-134A PRESSURE DROP IN P.S.I.				R-22 PRESSURE DROP IN P.S.I.					R-502 PRESSURE DROP IN P.S.I.					R410A FLOW CAPACITY EVAPORATOR TEMPERATURE (F°)				
	2	1.5	1	0.5	3	2	1.5	1	0.5	3	2	1.5	1	0.5	3	2	1.5	1	0.5
20151	2.7	1.8	1.1	0.6	4.6	2.8	1.9	1.1	0.6	4.3	2.6	1.7	1.0	0.6	4.2	2.8	1.8	1.2	0.6
20155	3.8	2.5	1.6	0.8	5.9	3.9	2.6	1.7	0.9	4.9	3.1	2.1	1.3	0.7	6.0	4.0	2.6	1.7	0.9

Flow Capacity In Tons Refrigerant¹ (For kW, Multiply Tons By 3.5)

¹ All ratings in accordance with ARI standard 730-04

² Example: 1.0 tons x 3.5 = 3.5 KW

MARS NO.	MODEL NO.	SIZE & TYPE	DIMENSION	
			A	B
20151	MSD-167S	7/8 ODF	7.13	2.5

Accessories

MARS Sight Glass - Moisture Indicators

The MARS Moisture Indicators are constructed of forged brass bodies with brass fittings. The large viewing area of the sight glass allows for quick and easy inspection of the refrigerant as it flows through the system. Bubbles passing through the sight glass may be an indication of a low system charge or a restriction in the refrigerant system.

The moisture Indicators are designed to provide an accurate method of determining when the moisture content is dangerously wet in a refrigerant system and when the liquid line drier is no longer effective. An indicator element is highly sensitive to moisture and will gradually change color in reaction to the moisture content of the refrigerant system. Maximum working pressure is 680 PSIG. Minimum Burst pressure is 2500PSIG. UL and CSA listed.



MARS NO.	MARS MODEL NO.	DESCRIPTION	LENGTH X HEIGHT INCHES	CASE QTY.
65639	MSG-3SS	3/8 Solder x Solder	4.69 x 1.11	12
65640	MSG-4SS	1/2 Solder x Solder	4.88 x 1.29	12
65641	MSG-5SS	5/8 Solder x Solder	4.88 x 1.38	12
65642	MSG-7SS	7/8 Solder x Solder	5.90 x 1.66	12

MARS Spun Copper Driers

Features:

- Recommended for use on original equipment, residential and commercial refrigerators, freezers and air conditioners
- XH-9 beaded molecular sieve for maximum water capacity in HFC refrigerants
- High quality – high capacity
- Hermetically sealed
- Easy break off grooved ends
- Copper shells and end tubes
- Compatible with R134

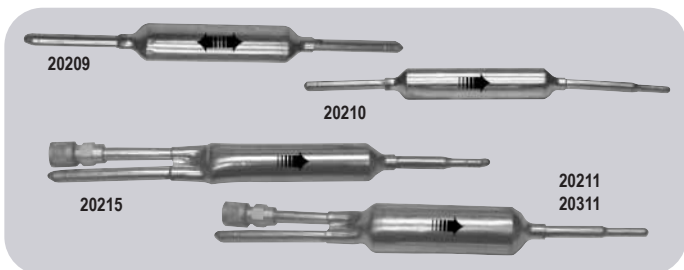

MARS Spun Drier Capacity Table

MARS NO.	DESCRIPTION	DROPS OF WATER REMOVED				RECOMMENDED TONNAGE	
		R-12		R-22		R-12	R-22
20209	Non-Directional	37.5	34	34	32	1/3	1/2
20210	Fused Ends	37.5	34	34	32	1/3	1/2
20211	Charging Drier	74	38	68	64	3/4	1
20311	Charging Drier	74	38	68	64	3/4	1
20215	Charging Drier	37.5	34	34	32	1/3	1

MARS	DESCRIPTION	INLET	OUTLET	LENGTH	DIA.	MARS
20209	Non-Directional	1/4" OD	1/4" OD	8-1/2"	3/4"	1
20210	Fused Ends	1/4" OD	1/4" OD	8-3/4"	3/4"	1
20211	Charging Drier	1/4" OD 1/4" Flare	1/4" OD or Cap.	8-3/4"	1"	1
20311	Charging Drier	1/4" OD 1/4" Flare	1/4" OD or Cap.	8-3/4"	1"	50
20215	Charging Drier	1/4" ID 1/4"OD 1/4"Flare	1/4" OD or Cap.	9"	3/4"	1

Tubing Cutters And Accessories

MARS offers a quality line of tube working tools, well recognized as standards of excellence in the HVACR industry.

MARS tube cutters can be used on hard or soft copper, aluminum, brass, thin wall steel, stainless steel, monel, titanium and other metal tubing. MARS #65001 and #6500 feature rollers with flare cut-off groove, fold away reamer and a spare cutting wheel.

MARS #65004, tube cutter, requires only 1 1/4" swing radius and a 1 3/8" swing radius with 5/8" tube. This tube cutter features rollers on the bottom of the tool which allows for easier cutter engagement on tubing.

The enclosed feed design minimizes contamination, assuring continued free operation. MARS #65005 requires only 1 11/16" swing radius.

MARS #65006, requires only 1 15/16" swing radius and a 2 1/4" swing radius with 1 1/8" tube.



MARS NO.	DESCRIPTION	CASE QTY.
65001	1/8" to 1 1/8" OD	20
65002	1/4" to 1 5/8" OD	10
65004	1/8" to 5/8" OD	20
65005	3/16" to 7/8" OD	10
65006	3/8" to 1 1/8" OD	10
65008	Standard cutter wheel (10 pk) for use on #65001, 65002, 65003, 65006	20

MARS Tube Benders



MARS NO.	DESCRIPTION	MARS PACK	CASE QTY.
25660	External spring type tube benders, 1/4", 3/8", 1/2" & 5/8", set of 4	1	24
65024	Triple header; 1/4", 5/16", 3/8" OD 15/16" radius to center	10	

Tubing Tool Kits

MARS #65059, 45° flaring and swaging tool kit is for use on 1/8", 3/16", 1/4", 5/16", 3/8", 7/16", 1/2" and 3/4" OD tubing. Flares or swages. Converts quickly. Features screw-type feed. Ideal close quarters tool. Swivel type swaging adapters and spreader cone are hard-chrome finished for easy operation. Self centering, slip-on forged steel yoke. Includes five swage adapters for 3/16", 1/4", 5/16", 3/8", 1/2" and 3/4" OD tubing. Packaged in a plastic kit.



MARS NO.	DESCRIPTION	CASE QTY.
65059	45° flaring and swaging tool	1

Flaring Tools

MARS #65038, 45° flaring tool is used for flaring and burnishing 3/16", 1/4", 5/16", 3/8", 1/2" and 5/8" OD tubing. The flares are rolled out above die bar by a super-smooth faceted cone. Automatically burnishes flare face. The slip-on yoke permits use in tight quarters. Heat treated dies grip tubing without scoring. For use on soft copper, aluminum and brass tubing.



MARS NO.	DESCRIPTION	CASE QTY.
65038	45° for 3/16" to 5/8" OD	10

Reversible Ratchet

MARS #65083 is for use on compressors with access valves in hard to reach places. This reversible ratchet is chrome plated.



MARS NO.	DESCRIPTION	CASE QTY.
65083	1/4", 3/8", 3/16", 5/16" square ratchet	1

Stainless Steel Vibration Absorbers

- 100% Copper connections
- Hose and copper braze welded
- Each unit dehydrated and vacuum tested
- Units individually packaged in poly bags and corrugate boxes
- UL, cUL, and CE

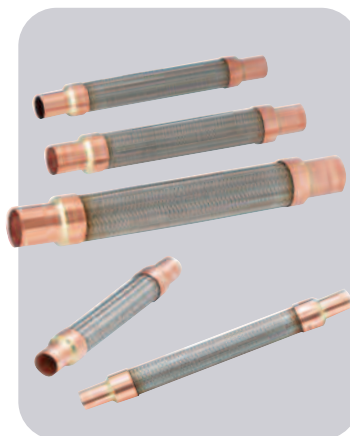

MARS NO.	DESCRIPTION	MARS PACK
52329	1/4" Vibration Absorber	1
52330	3/8" Vibration Absorber	1
52331	1/2" Vibration Absorber	1
52332	5/8" Vibration Absorber	1
52333	3/4" Vibration Absorber	1
52334	7/8" Vibration Absorber	1
52335	1-1/8" Vibration Absorber	1
52336	1-3/8" Vibration Absorber	1
52337	1-5/8" Vibration Absorber	1
52338	2-1/8" Vibration Absorber	1
52339	2-5/8" Vibration Absorber	1
52340	3-1/8" Vibration Absorber	1

MARS Flexible Mini-Split Line Set Connectors

MARS flexible line set connectors provide ease of installation for mini-split indoor evaporator units. Flexible line sets allow for line set connection prior to mounting the unit on the wall. Flexible line sets eliminate copper line kinking during the installation process and provide for future ease of service of the AC unit. All flex line sets are 36in. in length to facilitate installation of wall mount evaporators.



Features

- High pressure stainless steel braided line rated to 800 PSI
- R410a compatible
- 3 inch copper stubs
- 36 inch overall length

MARS NO.	DESCRIPTION	MARS PACK
52345	1/4" X 36" Mini-Split Flex Line Set	1
52346	3/8" X 36" Mini-Split Flex Line Set	1
52347	1/2" X 36" Mini-Split Flex Line Set	1
52348	5/8" X 36" Mini-Split Flex Line Set	1

Accessories

For Channels & Channel Fittings Hardware

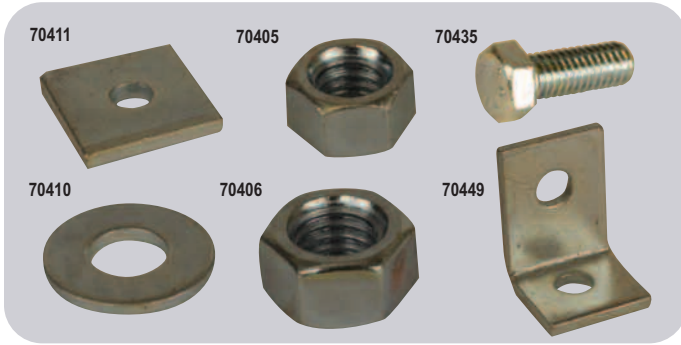

MARS NO.	DESCRIPTION	MARS PACK
70401	Insulated Plastic Staple	50
70411	3/8" Steel Square Washer	100
70410	3/8" Steel Flat Washer	100
70405	3/8" Steel Standard Hex Nut	100
70406	1/2" Steel Standard Hex Nut	100
70435	3/8" x 1" Steel Hex Head Cap Screw	100
70449	90 Deg, 2 Hole, Steel Angle Fitting (1-5/8 x 2-1/4)	50

Top Spring Nuts For All Channels

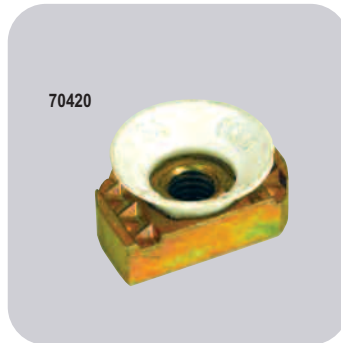

MARS NO.	DESCRIPTION	MARS PACK
70420	3/8" Nylon Cone Nut	100

Beam Clamp

MARS C-Clamp's are used to replace various other clamps as top beam or bottom beam structural steel attachments. Made of malleable/ductile iron, set screw with hardened cup point, lock nut



MARS NO.	DESCRIPTION	MARS PACK
70416	3/8" C-Clamp with Locknut	100
70415	3/8" Top Beam C-Clamp	100

Rod Coupling

MARS NO.	DESCRIPTION	MARS PACK
70425	3/8" Steel Rod Coupling	50

Supports non-insulated, stationary lines, Rigid/IMC Conduit and pipe

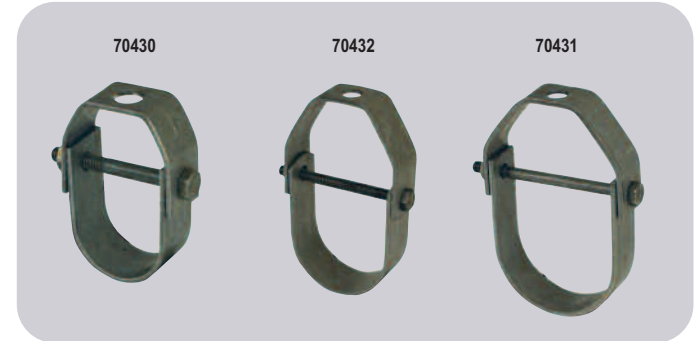

MARS NO.	DESCRIPTION	MARS PACK
70430	1" IPS Clevis Steel Pipe Hanger	100
70432	1-1/2" IPS Clevis Steel Pipe Hanger	50
70431	2" IPS Clevis Steel Pipe Hanger	100

Conduit & Pipe Hangers

Supports EMT and Rigid conduit or pipe.

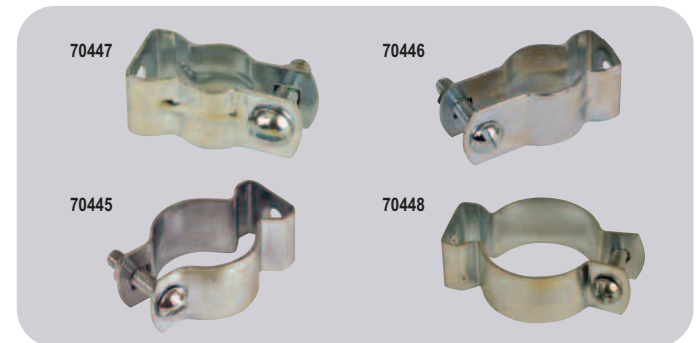

MARS NO.	DESCRIPTION	MARS PACK
70447	3/8 to 1/2" Conduit & Pipe Hanger w/bolt	100
70446	3/4" Conduit & Pipe Hanger w/bolt	100
70445	1" Conduit & Pipe Hanger w/bolt	100
70448	1-1/4" Conduit & Pipe Hanger w/bolt	100



Pipe Cushion Clamps

Pipe Straps are designed to be twist inserted anywhere along the slot side of the channel

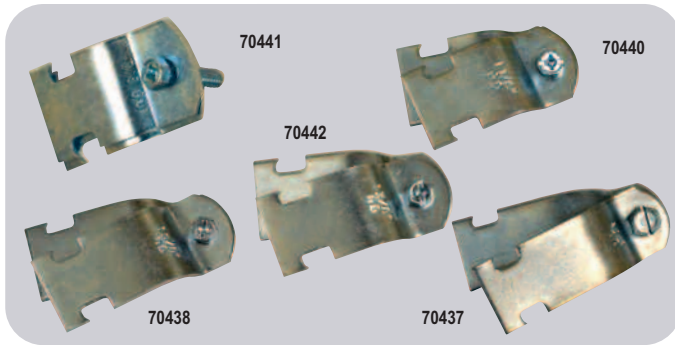

MARS NO.	DESCRIPTION	MARS PACK
70441	7/8" to 2" Adjustable Clevis Pipe Hanger	100
70440	1-1/8" to 2" Adjustable Clevis Pipe Hanger	100
70442	1-3/8" to 2 1/2" Adjustable Clevis Pipe Hanger	100
70438	1-5/8" to 2-1/2" Adjustable Clevis Pipe Hanger	100
70437	2-1/8" to 3" Adjustable Clevis Pipe Hanger	50
70439	2-3/8" to 3" Adjustable Clevis Pipe Hanger	25

Cushion Clamps



MARS NO.	DESCRIPTION	MARS PACK
70436	1-5/8" Steel Pipe Clamp w/Copper Plated OD Tubing	10

Sil-Fos Brazing Alloys - 1/8" X .05" X .20"- 1 Lb. Spool

Sil-Fos® alloys allow the joining of copper to copper without a flux and copper based alloys (brass and bronze) with a flux. Sil-Fos® is the workhorse filler metal used in the a/c and refrigeration industry. A key factor is the ductility of Sil-Fos® 15. It can be readily bent (without heating), thus permitting easier access to the backsides of joints.

The Sil-Fos® 15 is the best alloy for general copper-copper brazing in the Sil-Fos® family. The phosphorus in the Sil-Fos® product serves as the fluxing agent and no separate flux is necessary. For brass applications

however, flux is recommended. For use where close fit-ups cannot be maintained Sil-Fos® 15 works well to "bridge" gaps. Sil-Fos® 15 is the most ductile of the entire Sil-Fos® family to best withstand the stresses inherent in refrigeration applications. Slow Flow.

The Sil-Fos® 6M is recommended for use where close fit-ups cannot be maintained. It has the ability to fill gaps and form fillets without affecting joint strength. Slow Flow.

The Sil-Fos® 5 is designed primarily for those applications where close fit-ups cannot be maintained. It has the ability to fill gaps and form fillets without adversely affecting joint strength. Slow Flow.

Fos-Flo® 7 is an economical, very fluid medium temperature filler metal for use with copper, brass and bronze. Withstands moderate vibration. Fast Flow.



MARS NO.	AWS SPEC	COMPOSITION %			TEMPERATURE		MARS CASE PACK	QTY.	
		AG	CU	P	MELT	FLOW			
78301	Sil-Fos® 15	BCuP-5	15	80	5	1190° F	1475° F (1300°)	1	25
78302	Sil-Fos® 6M	BCuP-4	6	88	6	1190° F	1460° F (1300°)	1	25
78303	Sil-Fos® 5	BCuP-3	5	89	6	1125° F	1495° F (1300°)	1	25
78304	Fos-Flo® 7	BCuP-2		92.8	7.2	1310° F	1460° F (1350°)	1	25

Accessories

High Silver Brazing Alloys - 1/16" Dia. Coils



In refrigeration applications, much of the brazing involves joining copper tubing. However, there are numerous applications where other materials need to be joined (steel, brass, stainless, etc.). These high silver brazing alloys facilitate the joining of these metals. The one alloy in particular which is highly recommended for virtually all above mentioned base metals is Braze® 505. It's advantages over 56% and 45% include:



- It contains 2% Nickel which enhances wetting and strength and facilitates the joining of steels, stainless steel, carbide, etc.
- It doesn't contain tin. This prevents the formation of brittle intermetallics which can cause joint failures when stresses accumulate.
- The flow characteristics can be easily manipulated by either fast or slow heating techniques - this allows bridging of gaps.
- It's available in flux-coated rod for added convenience and ease-of-use: No separate fluxing operation.

Braze® 505 is the best general purpose filler metal available. It is the only alloy recommended for stainless steel (as it retards/eliminates interface corrosion) and carbide applications. Nickel content provides superior adhesion ("wetting") to base metal surfaces. Available, and especially convenient, as flux coated rod. Cadmium-free.

MARS NO.	AWS SPEC	COMPOSITION %					TEMPERATURE		MARS CASE PACK	MARS CASE QTY.
		AG	CU	ZN	SN	OTHER	MELT	FLOW		
78308	Braze® 505 1oz	BAg-24	50	20	28	2 Ni	1220° F	1305° F	1	24
78314	Braze® 505 F/C, Flux coated rod, 18" stick x 1/4 lb tube	BAg-24	50	20	28	2 Ni	1220° F	1305° F	1	15

Brazing & Solder Fluxes



Where fluxing is required as part of the brazing operation, Handy Flux is recommended. Handy Flux is an all-purpose flux for use in brazing both ferrous and non-ferrous metals and alloys. Handy Flux conforms to: AWS Brazing Flux Type #3A, Federal Spec. O-F-499d (216185) Type B, Society of Automotive Engineers AMS-3410G. For soldering applications we offer two different flux products depending on the materials to be joined. They include Clean-n-Brite Flux for general purpose applications and TEC Liquid Flux where more aggressive fluxing is required for the more difficult-to-solder materials (e.g. steel, stainless steel, etc.).



MARS NO.	DESCRIPTION	MARS PACK	CASE QTY.
78315	Handy Flux - 7oz. jar w/brush cap	1	24

Silver Bearing Soft Solders - 1/8" X 1 Lb. Spool



Clean-n-Brite solders are a high strength general purpose solder. They offer a higher strength than Tin/Lead solders and are safe for potable water systems. These alloys are widely used in low stress, low pressure copper-copper and copper-steel applications (e.g. sight glasses where temperature must be kept low, etc.).



Clean-n-Brite is a Lead-free, silver-bearing high-strength solder used for applications requiring close joint clearances.

Clean-n-Brite 6 is a Lead-free, silver-bearing high-strength solder used for applications requiring large joint clearances. It is the easiest Silver-bearing soft solder to work with as temperature range permits "bridging" loose fit-ups if necessary.

Clean-n-Brite No Lead is a Silver-bearing solder with good strength used in potable water system applications requiring no lead.

MARS NO.		COMPOSITION %			TEMPERATURE		MARS CASE PACK	MARS CASE QTY.
		AG	CU	P	MELT	FLOW		
78316	Clean-n-Brite	3.6	96.4		431° F	431° F	1	24
78317	Clean-n-Brite 6	6	94		431° F	535° F	1	24
78318	Clean-n-Brite No Lead	0.5	4	95.5	428° F	446° F	1	24

MARS Cross Reference Guide

MARS NO.	HANDY HARMON	LUCAS MILHAUPT	J.W. HARRIS	ENGELHARD
78302	Sil-Fos 6M	95120	66000 (Dynaflow)	Silvaloy 6
78303	Sil-Fos 5	95060	41035 (Stay-Silv 5)	Silvaloy 5
78304	Fos-Flo 7	95000	21035 (Stay-Silv 0)	Silvaloy 0
78308	Braze 505 (1oz.)	98070		
78314	Braze 505 F/C	98110		
78315	Handy Flux	97030	40022 (Stay-Silv Flux)	Ultra Flux
78316	Clean-n-Brite	96000	10001 (Stay-Brite)	Silvabrite
78317	Clean-n-Brite 6	96010	10009 (Stay-Brite 8)	Silvabrite S
78318	Clean-n-Brite (no lead)	96150	15000 (Stay-Safe 50)*	Silvabrite 100

* While this material does not have a chemistry exactly equivalent, it is similar in composition to Clean-n-Brite no lead and typically used in similar applications.

Specialty Tools

The MARS telescoping pilot match holder with magnet collapses to fit in shirt pocket. Extends to 25". Attractively packaged and barcoded for merchandising



MARS NO.	DESCRIPTION	MARS PACK
79130	Pilot match holder	1

Inspection Mirrors

MARS offers inspection mirrors for virtually any application! Telescoping types available, along with round glass, oval glass, rectangular glass, round metal and rectangular metal. Attractively carded and barcoded.



MARS NO.	DESCRIPTION	MARS PACK
79350	1 1/4" round dia.glass mirror with 6" arm, adjustable angle	1
79351	2 1/4" round dia.glass mirror with 10 1/2" arm, adjustable angle	1
79352	1" x 2" oval glass mirror with 6" arm, adjustable angle	1
79353	2 1/8" x 3-1/2" rectangle glass mirror with 11-12" extendible arm	1
79358	2 1/4" dia.round magnifying glass mirror with vinyl grip handle 14 1/2"	1

Filter Reach Tool 2

The Filter Reach Tool 2 is the first tool to correctly pull filters from large tonnage Air Conditioning units and Air Handlers. A must have tool for all HVAC mechanics. The telescoping stainless steel shaft extends up to 8' to grab and remove the hardest to reach filters. The powder coated safety orange Hook pivots down so the tool doubles as a magnetic pickup to retrieve dropped parts and tools. The high strength magnet will save you time and money by retrieving dropped tools and hardware.



Made in the USA Domestic & Foreign Materials

- Hook pivots down for 5lb. magnetic pickup
- Fits in any bag
- 304 Stainless steel
- Anodized aluminum

MARS NO.	DESCRIPTION	MARS PACK
79348	Filter Reach & Magnetic Tool 2	6

Accessories

Compressor Terminal Repair Kit

Zebra Instruments offers a compressor terminal repair kit. The terminals are high-temp soldered to the 10ga. fine strand, color coded wires for the best connection. These special terminals allow clearance for compressor post, and lay flat under the safety cover. Twist on wire nuts also provided.



MARS NO.	DESCRIPTION	MARS PACK	CASE QTY.
08565	Compressor Terminal Repair Kit 1 set of 3, terminals/wires/connectors	1	24

MARS Compressor Stake On Repair Kits



MARS Term-Lok compressor stake on repair kits are designed with the technician in mind! During servicing of the air conditioning system or refrigeration system, it is not unusual for a technician to remove the compressor cover to find the electrical connector or spade terminal broken or melted away from the compressor. In reconnecting the electrical power, the metal plate is often found to have deteriorated to such an extent that the conventional female connector will no longer attach to the spade type male connector. Technology for reattaching a metal plate to the metal pin without damaging the encapsulated block is not normally available thus requiring the technician to attempt various types of crimping arrangements to avoid replacing the compressor assembly (which normally does not work).

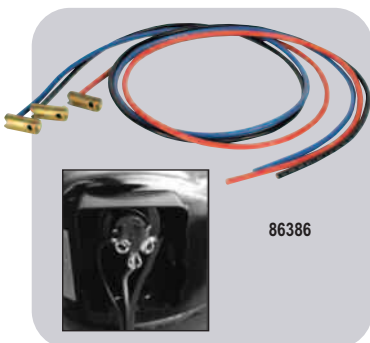

The MARS Term-Lok is a brass cylindrical tube with a diameter large enough to slip over the pins and has a stainless set screw to lock onto the terminal. Term-Lok comes in packages of one or three terminal locks with color coded 65 strands, 600 volt permanently attached wire, with wrench provided for easy application. Once installed the compressor cover may be placed back over the terminals without any obstructions.

It takes approximately 15 minutes to install on most systems, thus saving the technician time and the customer money, with virtually no call backs.

MARS NO.	DESCRIPTION	MFG. NO.	CASE QTY.
86386	Brass stake on 12 gauge - 3 wire, 3' leads	TLC-3-12	1
86388	Brass stake on 10 gauge - 3 wire, 3' leads	TLC-3-10	1
86390	Brass stake on 8 gauge - 3 wire, 3' leads	TLC-3-8	1

Quick Disconnects - Insulated (105°C)

MARS solderless terminals are competitively priced, yet manufactured of superior quality materials to rigid quality control standards. Seams are brazed to ensure perfect crimps EVERY TIME!

MARS solderless terminals are UL listed and CSA certified. Terminals are all manufactured in the USA. They are provided in clear, reclosable plastic display boxes. These attractive boxes, with clear and easy-to-read labels provide for visual inspection of the product and encourage impulse buying.

All packages display a MARS bar code for your convenience. MARS solderless terminals are available in two different package sizes. Both sizes enhance contractor self service.

The MARS mini-pak display boxes contain very reasonable quantities with all types and sizes sold at one price. Perfect for the handyman, do-it-yourselfer and your sales and counter people. The MARS mini-pak is excellent for that small, unique HVACR odd job. The MARS super-pak contains much larger quantities of the more common solderless terminals at a super value. The contractor and tradesman will make great use of this size reclosable package. Ask your MARS sales representative about our solderless terminal merchandiser program!



MARS NO.	MINI-PAK QTY.	SIZE	DESCRIPTION	MARS NO.	SUPER PAK QTY.
86200	20	22-18	.250 (1/4) female tab	86500	100
86201	20	16-14	.187 (3/16) female tab	86501	100
86202	20	16-14	.250 (1/4) female tab	86502	100
86203	15	12-10	.250 (1/4) female tab	86503	50
86219	20	22-18	.187 (3/16) female tab		
86205	20	16-14	.250 (1/4) male tab	86505	100
86207	12	22-18	.250 (1/4) female full insul.	86507	100
86208	12	16-14	.250 (1/4) female full insul.	86508	100
86209	8	12-10	.250 (1/4) female full insul.	86509	50
86220	7	16-14	.250 (1/4) female flag fully insul.	86520	25
86221	6 pair		combo of #86208, 09		
86211	12	16-14	.250 (1/4) male fully insul.		
86216	12	22-18	.250 (1/4) male/female p/back		
86217	12	16-14	.250 (1/4) male/female p/back	86517	100
86218	8	12-10	.250 (1/4) male/female p/back	86518	50

**Quick Disconnects -
Non-Insulated (149°C)**



MARS NO.	MINI-PAK QTY.	SIZE	DESCRIPTION	MARS NO.	SUPER PAK QTY.
86226	25	16-14	.250 (1/4) female tab	86526	100
86229	25	16-14	.250 (1/4) female flag	86529	100
86236	13	12-10	.250 (1/4) female flag		

**Quick Disconnects -
Hi Temp To 900°F**

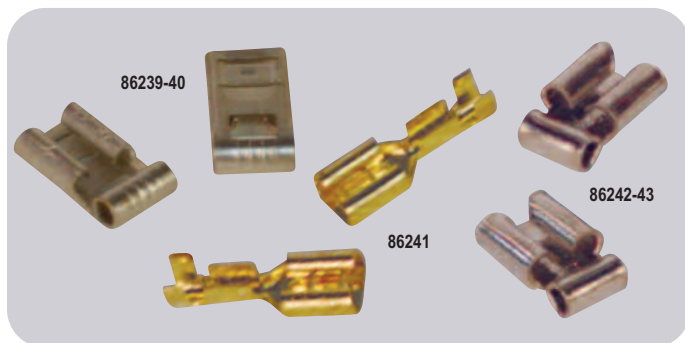

MARS NO.	MINI-PAK QTY.	SIZE	DESCRIPTION
86239	15	16-14	.250 (1/4) female tab
86240	12	12-10	.250 (1/4) female tab
86242	15	16-14	.250 (1/4) female flag
86243	10	12-10	.250 (1/4) female flag

Rings - Insulated (105°C)



MARS NO.	MINI-PAK QTY.	SIZE	DESCRIPTION	MARS NO.	SUPER PAK QTY.
86251	20	22-18	#8 stud 11/64 i.d.	86551	100
86252	20	22-18	#10 stud 13/64 i.d.		
86253	20	16-14	#6 stud 9/64 i.d.		
86254	20	16-14	#8 stud 11/64 i.d.	86554	100
86255	20	16-14	#10 stud 13/64 i.d.	86555	100
86258	12	12-10	#8 stud 11/64 i.d.		
86259	12	12-10	#10 stud 13/64 i.d.	86559	50
86260	12	12-10	1/4 stud 17/64 i.d.		
86262	5	8	1/4 stud 17/64 i.d.	86562	25

**Rings - Non-Insulated
(149°C)**



MARS NO.	MINI-PAK QTY.	SIZE	DESCRIPTION	MARS NO.	SUPER PAK QTY.
86275	15	12-10	#10 stud 13/64 i.d.		

**Rings - High Temp
To 900°F**



MARS NO.	MINI-PAK QTY.	SIZE	DESCRIPTION
86283	20	16-14	#10 stud 13/64 i.d.
86285	15	12-10	#10 stud 13/64 i.d.

Accessories

Spade Flanged - Insulated (105°C)



MARS NO.	MINI-PAK QTY	SIZE	DESCRIPTION
86294	15	16-14	#10 stud 13/64 i.d.
86295	12	12-10	#10 stud 13/64 i.d.

Spade - Insulated (105°C)

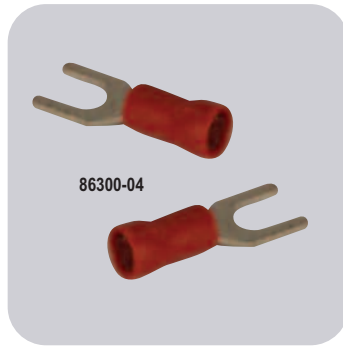

MARS NO.	MINI-PAK QTY	SIZE	DESCRIPTION	MARS NO.	SUPER PAK QTY.
86300	20	22-18	#8 stud 11/64 i.d.	86600	100
86303	20	16-14	#8 stud 11/64 i.d.	86603	100
86304	20	16-14	#6 stud 9/64 i.d.		
86301	15	16-14	#10 stud 13/64 i.d.	86601	100
86302	12	12-10	#10 stud 13/64 i.d.	86602	50

Spade - Non- Insulated (149°C)



MARS NO.	MINI-PAK QTY	SIZE	DESCRIPTION
86315	25	22-18	#10 stud 13/64 i.d.
86317	15	12-10	#10 stud 13/64 i.d.

Spade Hi Temp To 900°F



MARS NO.	MINI-PAK QTY	SIZE	DESCRIPTION	MARS NO.	SUPER PAK QTY.
86323	20	16-14	#10 stud 13/64 i.d.	86623	100

Butt Connectors And Plugs And Receptacles



MARS NO.	MINI-PAK QTY	SIZE	DESCRIPTION	MARS NO.	SUPER PAK QTY.
86329	20	22-18	Insulated	86629	100
86330	20	16-14	Insulated	86630	100
86331	15	12-10	Insulated	86631	50
		8	Non-insulated	86635	25
		16-14	Plug insulated Recept - fully insulated	86638	50 pairs

Closed End Connectors (105°C)



MARS NO.	MINI-PAK QTY	SIZE	DESCRIPTION	MARS NO.	SUPER PAK QTY.
86341	25	22-18	Insulated crimp type		
86342	20	16-14	Insulated crimp type	86642	100
86343	15	12-10	Insulated crimp type	86643	50

Tab Adapters - Non Insulated (149°C)



MARS NO.	MINI-PAK QTY	SIZE	DESCRIPTION	MARS NO.	SUPER PAK QTY.
86350	20	-	.250 (1/4) 2 male x 1 female	86650	100
86351	15	-	.250 (1/4) 2 male x 1 female 8 stud, male tab, straight, .250	86651	50
86353	12	-	.250 (1/4) 2 male x 1 female		

Compressor Terminals - Non Insulated (149°C)



MARS NO.	MINI-PAK QTY	SIZE	DESCRIPTION	MARS NO.	SUPER PAK QTY.
86358	13	12-10	.250 (1/4) tab notched for bending	86658	50
86359	8	12-8	.250 (1/4) tab	86659	50

Spade Spring - Insulated (105°C)



MARS NO.	MINI-PAK QTY	SIZE	DESCRIPTION	MARS NO.	SUPER PAK QTY.
86366	20	16-14	#8 stud	86666	100
86367	20	16-14	#6 stud		

Compressor Terminal W/Wire Kit

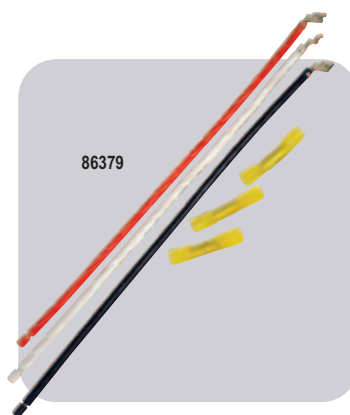

MARS NO.	DESCRIPTION	MARS PACK
86379	Includes 3 color coded #10AWG type AWM extra flexible lead wires in 10" lengths. One end with .250" x .032" female tab 12-10 quick disconnect. Other end stripped 5/16". Supplied with three 12-10 shrink tube butt connectors.	1

Push-On Terminal Kit

The MARS push on terminal kit includes; four push on terminal adapters and four screws. Converts screw type terminals to push on. Use with the MARS 18000 series contactors.



MARS NO.	DESCRIPTION	MARS PACK
93103	(4) push on terminal adapters (4) screws	1

MARS Pilot Burner Gas Lines

MARS pilot burner gas line is 6.5 ft of clean aluminum tubing with compression nuts and sleeves. Coiled and individually polybagged.



MARS NO.	DESCRIPTION	MARS PACK
79126	1/4" OD x 6.5' aluminum tubing	1

Accessories

MARS Clear Vinyl Tubing, - Boxed

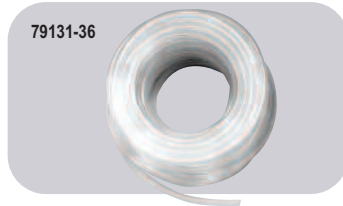

MARS NO.	DESCRIPTION	CASE QTY.
79131	1/4" ID clear tubing 32 PSI - .375 O.D.	100 feet
79132	3/8" ID clear tubing 27 PSI - .500 O.D.	100 feet
79133	1/2" ID clear tubing 24 PSI - .625 O.D.	100 feet
79134	5/8" ID clear tubing 21 PSI - .750 O.D.	100 feet
79135	3/4" ID clear tubing 19 PSI - .890 O.D.	100 feet
79136	7/8" ID clear tubing 16 PSI - 1.015 O.D.	50 feet

MARS Heavy Duty PVC Braided Line Tubing

- 41°F (5°C) to 140°F (60°C)



MARS NO.	DESCRIPTION	WORKING PRESSURE	BURST PRESSURE	CASE QTY.
79045	1/4" ID - .407 OD	120 PSI	360 PSI	50 Feet
79046	3/8" ID - .532 OD	120 PSI	360 PSI	50 Feet
79047	1/2" ID - .673 OD	90 PSI	270 PSI	50 Feet
79048	5/8" ID - .822 OD	90 PSI	270 PSI	50 Feet
79049	3/4" ID - .986 OD	90 PSI	270 PSI	50 Feet

MARS Saddle Valve

- Self-tapping
- Provides low volume water supply for a variety of appliances using 1/4" inlet tubes, with out the necessity of soldering, cutting pipe or drilling



MARS NO.	DESCRIPTION	CASE QTY.
79139	MARS saddle valve	1

MARS Corrugated Condensate Drain Line

- Ideal for Ductless Mini-Split
- 5/8" Diameter, 20 Ft. Long
- Flexible Ivory
- Corrugated non-kink

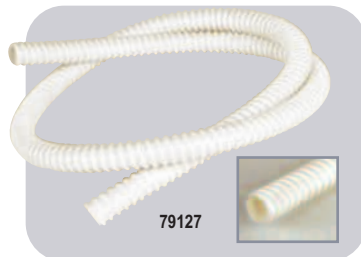

MARS NO.	DESCRIPTION	MARS PACK
79127	5/8" Diameter x 20 ft long, Condensate Drain Line	1

MARS Condensate Overflow Switches

The MARS Condensate Overflow Switches are designed to prevent condensate overflow and damage due to clogged drain lines. Overflow switches can be installed in primary or auxiliary condensate drain lines and pans. The overflow switch will interrupt the thermostat circuit and shut down the AC unit preventing an overflow of condensate. The overflow switch prevents condensate overflow damage to walls, floors and ceilings. All switches comply with all applicable NEC Codes and conform to UL 508 requirements.

MARS 21792 Designed for Auxiliary Drain Pans

- Switch is Height Adjustable
- Easy Clip - Stainless Steel Bracket
- Switch Components are Sealed for Reliability
- 6' 18 AWG Lead Wires for Ease of Installation
- Replaces SS3

MARS 21793 T - Fitting Designed for Primary or Auxiliary Drain Lines

- Kit Includes Standard Tee and Elbow
- Also Includes 3/4" Adapter and Plug Fitting
- Float Cap is Easily Removed for Service / Clean-out
- 6' 18 AWG Lead Wires for Ease of Installation
- Sealed Switch for Reliability
- O-ring on float switch port provides leak-proof seal
- Replaces SS1

MARS 21794 L - Fitting Designed for Primary Pan - Auxiliary Outlet

- Kit Includes Elbow or L Fitting
- Float Cap is Easily Removed for Service / Clean-out
- 6' 18 AWG Lead Wires for Ease of Installation
- Sealed Switch for Reliability
- O-ring on float switch port provides leak-proof seal
- Replaces SS2

* All overflow switches are UL rated;

- 1.5A 24VAC (switching current)
- 2.5A 24VAC (carry current)

Cross Reference

MARS NO.	Rectorseal	Diversitech
21792	SS3	CS-3
21793	SS1	CS-1
21794	SS2	CS-2

MARS NO.	DESCRIPTION
21792	Bracket Flood Prevention Switch
21793	Tee Flood Prevention Switch
21794	Elbow Flood Prevention Switch



A/C Condensate Drip Pan Shut Off Control

The ACDP-C, A/C Condensate Leak Shutoff Control is a simple, reliable, device that provides years of trouble-free operation and water leak protection for HVAC systems while saving you hours of leak damage maintenance time and cost.

When a water leak is detected the controller interrupts the Air Conditioner thermostat control signal and shuts off the A/C unit, stopping further condensation, property leak damage, and potential for mold. A red LED illuminates upon leak detection. 24 VAC air conditioner control circuit.

You can easily mount the sensor externally as a leak monitor or in the pan as a condensate pan level monitor. The control module can be stand alone or wall mounted.

Features:

- Easy to install
- More reliable than a float switch
- Can be used as a level or external leak control
- Wall or stand-alone mount

Specifications:

- 110 dB audible alarm with integrated A/C cut-off switch
- 30" x 1" flat flexible patented ribbon sensor
- 24 VAC power from AC control board
- Red LED when activated
- 24" sensor leads, 36" power & thermostat leads



21910

MARS NO.	DESCRIPTION	PK QTY	CASE QTY
21910	A/C Condensate Leak Shutoff Control	1	6

Condensate & Hot Water Heater Leak Alarm

The ACDP-A, A/C Condensate and Hot Water Heater Leak Alarm is a simple, reliable, device that provides you years of trouble-free operation and protection for dual or single systems while saving you hours of water leak damage maintenance time and cost.

No floats to corrode or hang up. Utilizes two of our patented 30-inch flat flexible ribbon sensors that offer superior wide area water leak coverage. One sensor mounts at the A/C unit and the second one mounts at the HWH drain. When it senses a water leak it activates the 110 decibel alarm. The 24" and 40" sensor leads allow for easy location. Sensors can be mounted externally as a leak monitor or in the drip pan as a level monitor. The housing can be stand alone or wall mounted

Features:

- Easy to install
- Ideal for mechanical rooms requiring more than a single point of protection
- Sensor leads of 24 and 40 inches for easy mounting
- Affordable, Saves expense, maintenance time, frustration
- Wall or stand-alone mount

Specifications:

- 110 dB audible alarm
- (2) 30" x 1" flat flexible ribbon sensors
- Can be uses as dual or single sensor systems for A-Coil and/or HWH
- Very loud 110 dB alarm,
- 9V dc battery power

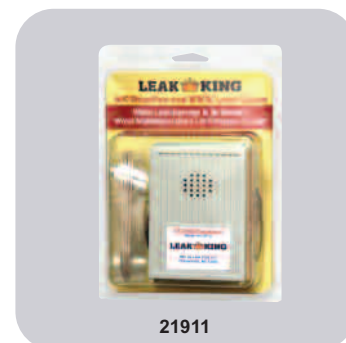

21911

MARS NO.	DESCRIPTION	PK QTY	CASE QTY
21911	Condensate and Hot Water Heater Leak Alarm	1	6

Wide Area Water Leak Alarm

The WALA, Wide Area Leak Alarm provides a proven warning system for water leaks that can cause you water damage in out of sight or remote places in your home. Most leak detectors are 'point sensors', only detecting a leak if it puddles right where the alarm housing is located and with enough depth to come into contact with both conductors.

The innovative design of Leak King's Wide Area Leak Alarm allows the 30" long flat, flexible, ribbon sensor to detect leaks across a long 30" ribbon. The 110 dB alarm alerts you before expensive property damage occurs. It is particularly useful for water leaks under kitchen sinks, bathroom vanities, washing machines, water heaters, dishwashers, HVAC drains, and sumps and it provides simple, reliable, inexpensive, prevention against potential water damage and offers great peace of mind.

Features:

- Provides large area coverage
- Easy installation
- Does not interfere with under cabinet storage
- Works anywhere susceptible to leaks
- Smart, reliable, inexpensive leak protection

Specifications:

- 30" x 1" patented flat flexible ribbon sensor
- 110 dB alarm
- 9 vdc battery (not included) operated
- 24" sensor lead wire for easy placement



21912

MARS NO.	DESCRIPTION	PK QTY	CASE QTY
21912	Wide Area Water Leak Alarm	1	6

Accessories

Slic-Tite® Paste - Thread Sealants

LA-CO

- Use on metal, PVC, CPVC, and ABS plastic pipe threads
- For sealing water, air, steam, natural gas, LP gas, refrigerants, ammonia, gasoline, and oil
- Do not use on Oxygen service, use thread seal tape or Oxytite® Paste
- Washes off hands and clothing easily
- Non-toxic, non-drying
- Sealing temperature range: -50° F to 500° F (-46° C to 260° C)
- Working pressures: 3,000 PSI (204 BAR) for Gas, 10,000 PSI (680 BAR) for liquids
- USDA approved for use in federally inspected meat and poultry plants.
- Made in USA



MARS NO.	DESCRIPTION	MARS PACK	CASE QTY.
95401	1/4 pt. w/ brushcap	24	24
95402	1/2 pt. w/ brushcap	24	24

Low Density Thread Seal Tape

LA-CO

- Thickness 3 mils.
- Standard grade, low density
- Provides a highly resistant seal on pipe threads for all types of service
- Suitable for use with solvents, chemicals, oxygen, and on food lines
- Non-toxic
- Permits easy disassembly, even after years of service
- Meets Mil. Spec. T-27730A
- Sealing temperature range: -450° F to 550° F (-268° C to 288° C)
- Working pressures: 2,000 PSI (136 BAR)
- Sold in case quantities only.



MARS NO.	DESCRIPTION	MARS PACK	CASE QTY.
95409	1/2" x 260"	144	144
95410	1/2" x 520"	144	144
95412	3/4" x 520"	144	144

High Density Slic-Tite® Thread Seal Tape

LA-CO

- Thickness 3 mils.
- High density
- Provides a highly resistant seal on pipe threads for all types of service
- Made in USA
- Suitable for use with solvents, chemicals, oxygen, and on food lines
- Non-toxic
- Permits easy disassembly, even after many years
- Meets Mil. Spec. T-27730A
- Sealing temperature range: -450° F to 550° F, (-268° C to 288° C)
- Working pressures: 2,000 PSI (136 BAR)



MARS NO.	DESCRIPTION	MARS PACK	CASE QTY.
95527	1/2" x 300"	12	12
95528	1/2" x 600"	12	12
95530	3/4" x 300"	12	12

T.O.T.® Pipe Joint Compound

LA-CO

- No-drip, siliconized for fast application on metal threads
- For water, steam, air, and natural gas service
- Lead free, non-toxic
- Certified by NSF to meet ANSI/NSF Std. 61 for use on potable water
- Do not use on Oxygen service, use thread seal tape or Oxytite®
- Sealing temperature: up to 350° F (177° C)
- Working pressures: to 500 PSI (34 BAR) for liquids to 350 PSI (24 BAR) for gases
- Made in USA



MARS NO.	DESCRIPTION	MARS PACK	CASE QTY.
95415	1/2 pt. w/ brushcap	48	48

Pipetite® Paste - Pipe Thread Compound



- Soft set pipe thread compound
- For refrigerants, butane, gasoline, oil, as well as water, steam, air, natural and lp gas
- Use on metal threads
- Classified by Underwriters Laboratories in USA and Canada
- Do not use on oxygen service, use thread seal tape or Oxytite®
- Sealing temperature: up to 400° F (204° C)
- Pressures: to 5,000 PSI (340 BAR) for liquids to 2,600 PSI (177 BAR) for gases



MARS NO.	DESCRIPTION	MARS PACK	CASE QTY.
95419	1/4 pt. w/brush cap	24	24
95420	1/2 pt. w/brush cap	24	24

Anaerobic Pipe Thread Sealant



- Anaerobic adhesive provides locking power
- Contains no solvents, won't shrink and weaken seal
- Seals and locks in the absence of air
- Ideal for threads in heavy vibration areas such as compressors and reciprocating equipment
- Classified by Underwriters Laboratories in USA and Canada
- Do not use on Oxygen service, use thread seal tape or Oxytite®
- Sealing temperature range: - 65° F to 400° F (-54° C to 204° C)
- Working pressures: to 10,000 PSI (680 BAR) for liquids to 3,000 PSI (204 BAR) for gases
- Made in USA



MARS NO.	DESCRIPTION	MARS PACK	CASE QTY.
95421	50 ml (1.69 oz.)	12	12

Heat-Seal Stik®



- Fast repairs completed in 90 seconds
- One part epoxy, no mixing or measuring needed
- Stick melts, seals and cures in one operation
- Use on aluminum, copper and other metals, glass and ceramics
- Ideal for use on high and low side of refrigeration systems
- Sealing temperature : up to 350° F (177° C)
- Pressures: to 600 PSI (41 Bar)
- Made in USA

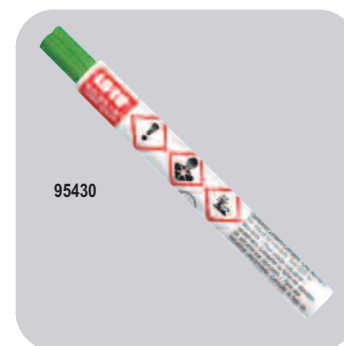

MARS NO.	DESCRIPTION	MARS PACK	CASE QTY.
95430	3/8 oz. stick, carded	12	12

Bloc-it® Heat Absorbing Paste



- Effectively absorbs surface heat
- Protects adjoining surfaces that may be damaged by excessive heat
- Safe to use: non-toxic, no asbestos, harmless to skin, and odorless
- Easy to use: apply directly to surface from tube
- Easy to clean: wipe off with cloth or wash with water. Leaves no stains
- Typical uses: protects rubber and plastic components in ball, dielectric, and solenoid valves during soldering; protects painted or finished surfaces from adjacent soldering, brazing or welding; prevents distortion to light gauge metals during brazing or welding
- Made in USA



MARS NO.	DESCRIPTION	MARS PACK	CASE QTY.
95455	10 oz. tube	24	24

Accessories

Cool Gel - Heat Dissipating Spray

LA-CO.

- Helps prevent heat damage to components and surrounding materials during soldering, brazing, and welding
- Unique gelled formula sticks to surfaces without dripping or running off
- Clear, non-staining gel leaves no residue, eliminating cleanup
- Safe, non-toxic, harmless to skin and odorless
- Saves time - by eliminating the costly disassembly of valves and other components before soldering, brazing or welding
- Protects the seals and seats in ball, dielectric, and solenoid valves
- Protects painted and finished surfaces from discoloration due to adjacent torch operations
- Protects soldered joints from loosening when soldering adjacent joints
- Made in USA



MARS NO.	DESCRIPTION	MARS PACK	CASE QTY.
95536	1 quart	12	12

Regular Flux Paste

- Super detergent action cleans as it solders
- Non-acid, non-toxic, lead free
- Contains no zinc chloride
- Use with all common soft solders including: tin-silver, 96/4, 94/6, 95/5, 50/50, 40/60 and 60/40
- For use on copper, brass, galvanized iron, lead, zinc, tin, silver, nickel, mild steel, terne plate, and malleable iron
- Meets Mil. Spec. Mil-F4995 Type II, Meets ASTM B813
- Water soluble for faster flushing from pipe lines
- Made in USA



MARS NO.	DESCRIPTION	MARS PACK	CASE QTY.
95441	2 oz	48	48
95443	4 oz. w/brushcap	48	48
95444	1 lb	24	24

Visu-Glow® Leak Detector

LA-CO.

- High visibility, fluorescent color shows brightly, even in dimly lit places
- High viscosity, stays on vertical surfaces
- Makes it easy to find leaks
- Temperature range: 15° F to 200° F (-9° C to 93° C)
- Safe for oxygen
- Non-corrosive, non-toxic
- Made in USA



MARS NO.	DESCRIPTION	MARS PACK	CASE QTY.
95462	8 oz.	24	24

Residential Self Regulating Pipe Tracing Cable



- Cut to length (3 watts/ft @ 120VAC) up to 75 ft.
- Braided metal jacket for dry location application
- Connection kit provides end seal and plugs into standard 120 VAC outlet
- Automatically varies heat output with changes in surrounding temperature
- For use on plastic or metal
- Recommended for use on PVC condensate lines
- A connection kit (70704) is required on each application
- 70705 is optional for each installation



MARS NO.	DESCRIPTION	MARS PACK	CASE QTY.
70701	100' Reel	1	1
70704	Connection Kit	1	10
70705	Pre-set Thermostat (38 degrees)	1	10

Commercial Pipe Freeze Protection Cable



- No thermostat, no plug
- 2 foot orange 14/3 cold lead
- Jacketed for wet or dry applications
- 120 VAC unless noted
- For use on metal pipes only



MARS NO.	DESCRIPTION	MARS PACK	CASE QTY.
70720	3.28' length, 23 watts	1	20
70721	6.56' length, 46 watts	1	20
70722	6.56' length, 46 watts (240V)	1	20
70723	9.84' length, 69 watts	1	20
70724	13.12' length, 92 watts	1	20
70725	13.12' length, 92 watts (240V)	1	20
70726	16.41' length, 115 watts	1	20
70727	19.69' length, 138 watts	1	20
70728	19.69' length, 138 watts (240V)	1	20
70729	22.97' length, 161 watts	1	10
70730	26.25' length, 184 watts (240V)	1	10
70731	29.53' length, 207 watts	1	10
70732	32.81' length, 230 watts (240V)	1	10

Residential Pipe Freeze Protection Cable



- For use on Plastic or Metal Water-supply pipes at least 3 feet in length
- Do NOT use on condensate lines
- The circuit supplying cable must have a ground fault circuit interrupter (GFCI)
- Jacketed for wet or dry applications
- Preassembled ready to install
- Plugs into standard 120 VAC outlet



MARS NO.	DESCRIPTION	MARS PACK	CASE QTY.
70710	3' length, 21 watts	1	10
70711	6' length, 42 watts	1	10
70712	9' length, 63 watts	1	10
70713	12' length, 84 watts	1	10
70714	15' length, 105 watts	1	10
70715	18' length, 126 watts	1	5
70716	24' length, 168 watts	1	5
70717	30' length, 210 watts	1	5
70718	40' length, 280 watts	1	5

Commercial Sr Trace Self Regulating Pipe Tracing Cable



- Cut to length, up to 458' (120VAC)
- Wet (J jacket) or dry (copper braid) applications
- Automatically varies heat output with changes in surrounding temperature



MARS NO.	DESCRIPTION	MARS PACK	CASE QTY.
70742	250' reel, J jacket 5 watts/ft, (120V)	1	1
70744	Heat shrink end seal kit	1	5
70745	Heat shrink power/end connection kit	1	1
70746	Heat shrink splice and "T" connection kit	1	2

Accessories

Ideal 52 Series - 1/2" Clamps



Ideal manufactures a broad line of standard worm drive and specialty hose clamps designed to satisfy a wide range of applications. The completely mechanical design locks the one piece housing directly to the band using the full strength of the material to provide maximum anti-shear protection. No spot welds to rupture under stress or corrosion, and a one piece housing can not come apart under high loading.

Ideal's 52 series clamps are comprised of a 1/2" stainless steel band with carbon steel housing and a 5/16" plated hex head screw.



MARS NO.	DESCRIPTION	MARS PACK	CASE QTY.
79310	Size 06 3/8"-7/8" clamp dia.	10	100
79311	Size 08 7/16"-1" clamp dia.	10	100
79312	Size 10 1/2"-1 1/8" clamp dia.	10	100
79313	Size 12 1/2"-1 1/4" clamp dia.	10	100
79314	Size 16 3/4"-1 1/2" clamp dia.	10	100
79315	Size 20 3/4"-1 3/4" clamp dia.	10	100
79317	Size 24 1"-2" clamp dia.	10	100
79318	Size 28 1 5/16"-2 1/4" clamp dia.	10	100
79316	Size 32 1 9/16"-2 1/2" clamp dia.	10	100
79319	Size 36 7/8"-2 3/4" clamp dia.	10	100
79345	Size 40 1-1/8"-3" clamp dia.	10	100
79309	Size 72 3-1/8"-5" clamp dia.	10	100

Ideal 67-5 Series 1/2" Clamps



Ideal's 67-5 series clamps are all stainless steel. They are comprised of a 1/2" 300 series stainless steel band, housing and a 5/16 hex head screw.



MARS NO.	DESCRIPTION	MARS PACK	CASE QTY.
79320	Size 06 3/8"-7/8" clamp dia.	10	100
79321	Size 08 7/16"-1" clamp dia.	10	100
79322	Size 10 1/2"-1 1/8" clamp dia.	10	100
79323	Size 12 1/2"-1 1/4" clamp dia.	10	100
79324	Size 16 3/4"-1 1/2" clamp dia.	10	100
79325	Size 20 3/4"-1 3/4" clamp dia.	10	100
79328	Size 24 1"-2" clamp dia.	10	100
79307	Size 28 1 5/16"-2 1/4" clamp dia.	10	100
79326	Size 32 1 9/16"-2 1/2" clamp dia.	10	100
79327	Size 36 7/8"-2 3/4" clamp dia.	10	100
79308	Size 72 3"-5" clamp dia.	10	100
79304	Size 128 6 1/2"-8 1/2" clamp dia.	50	100

Ideal 50 All Stainless 1/2" Clamp For Ducts



MARS NO.	DESCRIPTION	MARS PACK	CASE QTY.
79329	Size 248 14"-16" clamp dia.	50	100

Ideal 52 Series Micro Gear Clamps



Ideal's 52 series micro-gear clamps consist of a 5/16" stainless steel band with carbon steel housing and 1/4" plate hex-head screw.



MARS NO.	DESCRIPTION	MARS PACK	CASE QTY.
79330	Size 04 7/32"-5/8" clamp dia.	10	100
79331	Size 06 5/16"-7/8" clamp dia.	10	100
79332*	Size 12 9/16"-1 1/4" clamp dia.	10	100
79333*	Size 16 11/16"-1 1/2" clamp dia.	10	100
79334*	Size 20 7/8"-1 3/4" clamp dia.	10	100

* size 12 and larger have a stainless steel housing

Ideal 62M Series Micro Gear Clamps



Ideal's 62M series micro gear clamps are all stainless. They are comprised of a 5/16" stainless steel band, housing and 1/4" hex-head screw.



MARS NO.	DESCRIPTION	MARS PACK	CASE QTY.
79340	Size 04 7/32"-5/8" clamp dia.	10	100
79341	Size 06 5/16"-7/8" clamp dia.	10	100
79342	Size 12 9/16"-1 1/4" clamp dia.	10	100
79343	Size 16 11/16"-1 1/2" clamp dia.	10	100
79344	Size 20 7/8"-1 3/4" clamp dia.	10	100

Flexible Couplings

Flexible rubber couplings are used to connect cast iron, plastic, steel or lead pipe to cast iron, plastic, steel or lead pipe.

- All models are listed with I.A.P.M.O. (U.P.C.) 5/16" driver required to tighten bolts.
- All models are listed to the National Plumbing Code of Canada and relevant Canadian Standard(s) and bear the cUPC mark of conformity®
- Non constant temperature rating is 140°F.
- Stainless Steel Clamps and 5/16" hex head bolts are made from Type 300 Stainless Steel.

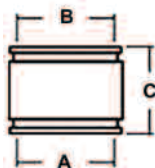

Note: Tighten bolts to 60 inch lbs. min. / max torque. Tested to maintain 4.3 p.s.i. maximum line pressure (10' head pressure) Tested and Certified to ASTM Standard 1173-2010.

MARS NO.	DESCRIPTION	A		B		C	MARS PACK	CASE QTY.
		MIN	MAX	MIN	MAX	HEIGHT		
85093	2" CI/PL/ST/LD x 2" CI/PL/ST/LD Flex coupling	2.20	2.50	2.20	2.50	3.50	1	100
85095	3" CI/PL/ST/LD x 3" CI/PL/ST/LD Flex coupling	2.60	3.18	2.20	3.18	2.75	1	100
85096	3" CI/PL/ST/LD x 2" CI/PL/ST/LD Flex coupling	2.60	3.18	2.20	2.50	2.75	1	100

Flexible Stainless Steel Gas Range Connectors 1/2" I.D. (5/8" O.D.) With Fittings

Brass Craft coated stainless steel gas connectors are known for superior quality and reliable performance. The ProCoat polymer based yellow coating resists corrosion from sea, salt, UV rays and the harsh chemical vapors from common household cleaning, plumbing repair and building products such as: ammonia, chlorine, solder flux, muratic acid, and bleach. These ProCoat gas connectors provide great strength and flexibility making installation easier.



MARS NO.	DESCRIPTION	MARS PACK	CASE QTY.
73402	18"L-1/2" MIP x 1/2" MIP	1	25
73403	24"L-1/2" MIP x 1/2" MIP	1	25
73404	36"L-1/2" MIP x 1/2" MIP	1	25
73405	48"L-1/2" MIP x 1/2" MIP	1	25
73418	36"L-1/2" FIP x 1/2" MIP	1	25
73419	48"L-1/2" FIP x 1/2" MIP	1	25
73431	24"L-1/2" FIP x 1/2" MIP	1	25
73432	36"L-1/2" FIP x 1/2" MIP	1	25
73433	48"L-1/2" FIP x 1/2" MIP	1	25

Flexible Stainless Steel Gas Dryer Connectors 3/8" I.D. (1/2" O.D.) With Fittings



MARS NO.	DESCRIPTION	MARS PACK	CASE QTY.
73439	36"L-1/2" MIP x 1/2" MIP	1	25
73440	48"L-1/2" MIP x 1/2" MIP	1	25
73445	24"L-1/2" FIP x 1/2" MIP	1	25
73446	36"L-1/2" FIP x 1/2" MIP	1	25

Steel Gas Fittings For 7/8" O.D. Connectors

With MARS male gas fittings, wholesalers need fewer items on the shelf and contractors need fewer parts on the job. Tapped gas fittings hook up gas connectors to male or female iron pipe and female in-line gas valves. One fitting does many jobs.



MARS NO.	DESCRIPTION	MARS PACK	CASE QTY.
73480	straight-5/8" OD x 1/2" MIP (tapped 3/8" FIP)	25	25
73481	straight-5/8" OD x 3/4" MIP (tapped 1/2" FIP)	25	25

MARS Gas Ball Valves

MARS gas ball valves are for use with natural, manufactured and mixed gases, as well as liquified petroleum and LP gas/air mixtures. Corrosion fighting chrome plated brass ball and aluminum, quarter turn handle. MARS gas ball valves feature threads that conform to all appropriate standards.

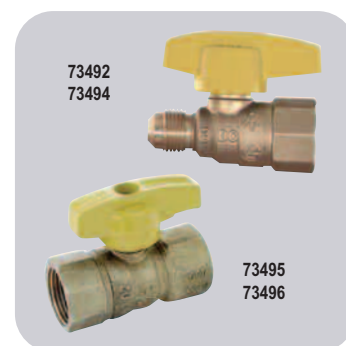

MARS NO.	DESCRIPTION	MARS PACK	CASE QTY.
73494	straight-5/8" OD x 3/4" FIP	10	10
73495	straight-1/2" FIP x 1/2" FIP	10	10
73496	straight-3/4" FIP x 3/4" FIP	10	10

Accessories

Oatey All Purpose Cement - ABS, PVC, CPVC

Oatey all purpose cement is a heavy bodied, clear cement recommended for use on ABS, PVC or CPVC pipe and fittings. For all pipe schedules, potable water pressure pipe, gas, conduit, drain waste and vent pipe. Flows freely and provides a thick layer of cement on the pipe. Helps to fill gaps in larger diameter pipe and loose fitting joints. Apply at temperature 40°F to 100°F.

Exceeds performance requirements of ASTM D-2564, D-2864, D-2235, F-493. Special applicator brush cap for fast and easy installation.



MARS NO.	DESCRIPTION	MARS PACK
73161	4 oz. clear	24
73162	8 oz. clear	24
73163	16 oz. clear	24

Oatey Heavy Duty Cement - PVC

Oatey heavy duty cement is recommended for use on pvc pipe and fittings up to 12" in diameter for schedule 40 and schedule 80 potable water pressure pipe, gas, conduit, drain waste and vent pipe. This heavy bodied cement flows freely and provides a thick layer of cement on the pipe. A special brush cap applicator is provided. Apply at temperatures 40°F to 100°F. This clear cement helps to fill gaps in larger diameter pipe and loose fitting joints. Exceeds ASTM D-2564.



MARS NO.	DESCRIPTION	MARS PACK
73165	4 oz. clear	24
73166	8 oz. clear	24
73167	16 oz. clear	24

Oatey Regular Cement - PVC

Oatey regular cement is recommended for use on PVC pipe and fittings up to 4" for DWV or schedule 40 and up to 2" for schedule 80 potable water pressure pipe, gas, conduit, drain waste and vent pipe. It flows freely and sets up quickly. Apply at temperatures 40°F to 100°F. Exceeds ASTM D-2564. Special brush top applicator.



MARS NO.	DESCRIPTION	MARS PACK
73174	4 oz. clear	24
73175	8 oz. clear	24
73176	16 oz. clear	24
73177	32 oz. clear	12

Oatey Rain-R-Shine™ Cement - PVC

Oatey Rain-R-Shine™ is a blue colored cement recommended for PVC pipe and fittings up to 6" in diameter. A very fast setting cement formulated for wet conditions and/or when quick pressurization and fast installation is needed. For schedule 40 and schedule 80 potable water pressure pipe, irrigation, gas, conduit, drain waste and vent pipe. This medium bodied cement flows freely and covers with a thicker layer than regular PVC. Apply at temperatures 40°F to 100°F.



MARS NO.	DESCRIPTION	MARS PACK
73150	4 oz. blue	24
73151	8 oz. blue	24

Oatey Clear Primer - NSF Listed - PVC, CPVC

Oatey clear primer is a clear aggressive primer for use on PVC and CPVC pipe and fittings for all schedules and diameters. This NSF listed formula removes all surface dirt, grease and grime as well as softens pipe in preparation for solvent cement. Meets ASTM F-656.



MARS NO.	DESCRIPTION	MARS PACK
73186	16 oz. clear	24

Oatey All Weather Cement-PVC

Oatey all weather cement is recommended for use on PVC pipe and fittings up to 6" in diameter. Formulated for fast initial set up at temperatures down to 10°F, for schedule 40 and schedule 80 potable water pressure pipe, gas, conduit, drain waste and vent pipe. This medium bodied, clear cement flows freely and maintains good gap filling properties. Apply at temperatures 10°F to 100°F. Exceeds ASTM D-2564.



MARS NO.	DESCRIPTION	MARS PACK
73156	16 oz. clear	24

Oatey Purple Primer - PVC, CPVC

Oatey purple primer is recommended for use on PVC and CPVC pipe and fittings, all schedules and diameters. This purple tinted aggressive primer is formulated to remove surface dirt, grease and grime, as well as, soften the pipe surface to allow for a fast, secure and permanent solvent weld. For use in area where code calls for verification that a primer has been used. Exceeds ASTM F-656.



MARS NO.	DESCRIPTION	MARS PACK
73178	4 oz. purple	24
73179	8 oz. purple	24
73180	16 oz. purple	24

Oatey All Purpose Cleaner - PVC, CPVC, ABS

Oatey all purpose cleaner is recommended for use on ABS, PVC and CPVC pipe and fittings, all schedules and diameters. This fast acting cleaner removes surface dirt, grease and grime. Flows freely and evaporates quickly. Does not penetrate pipe surface. Apply at temperatures 40°F to 100°F.



MARS NO.	DESCRIPTION	MARS PACK
73170	8 oz. clear	24
73171	16 oz. clear	24
73172	32 oz. clear	12

Schedule 40 - PVC Traps

- Lightweight, durable and cost effective
- Maximum service temperature 140°F
- High corrosion and chemical resistant, will not rust, scale, pit or corrode



MARS NO.	DESCRIPTION	MARS PACK
73126	3/4" P-trap	1
73128	3/4" mini P-trap	1
73129	3/4" super P-trap	1
73131	3/4" R trap	1
73133	3/4" PVC P-trap Clear	1
73136	3/4" PVC R-trap Clear	1

Adapter Nylon Fitting

- Nylon - white



MARS NO.	DESCRIPTION	CASE QTY.
73201	Adapter 1/4 barb x 1/4 MPT - 10/pack	1
73203	Adapter 3/8 barb x 3/8 MPT - 10/pack	1
73204	Adapter 3/8 barb x 1/2 MPT - 8/pack	1
73206	Adapter 1/2 barb x 1/2 MPT - 6/pack	1
73207	Adapter 1/2 barb x 3/4 MPT - 4/pack	1
73208	Adapter 5/8 barb x 3/4 MPT - 4/pack	1

Accessories

Elbow Nylon Fitting

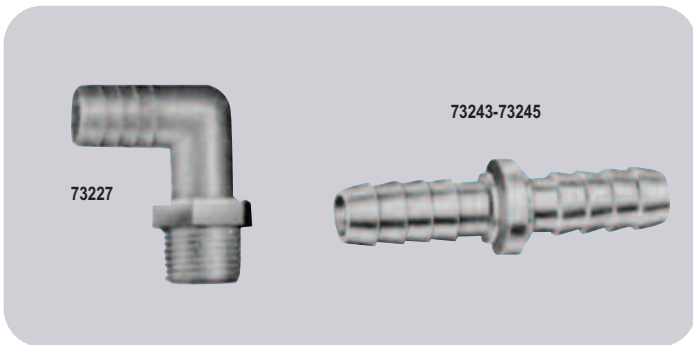

MARS NO.	DESCRIPTION	CASE QTY.
73230	Elbow 1/2 barb x 3/4 MPT - 4/pack	1
73232	Elbow 5/8 barb x 3/4 MPT - 4/pack	1
73234	Elbow 3/4 barb x 3/4 MPT - 4/pack	1
73243	Hose mender 3/8 barb - 5/pack	1
73244	Hose mender 1/2 barb - 4/pack	1
73245	Hose mender 5/8 barb - 4/pack	1

Tee Nylon Fitting

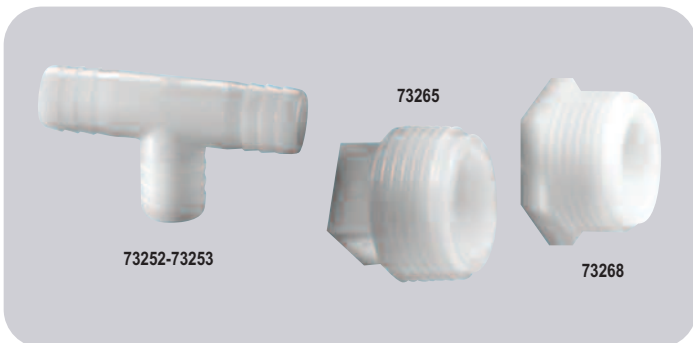

MARS NO.	DESCRIPTION	CASE QTY.
73252	Tee 3/8 x 3/8 x 3/8 barb - 5/pack	1
73253	Tee 1/2 x 1/2 x 1/2 barb - 4/pack	1
73265	Drain plug 3/4 square head - 5/pack	1
73268	Drain plug 3/4 hex head - 5/pack	1

MARS Condensate Clean-Out Tablets

MARS TAB™ condensate and drip pan clean-out tablets, prevent plugging of air conditioning condensate drip pans and drain lines.

MARS TAB™ does not release any chlorine or other noxious fumes. This economical, simple positive protection can be used on steel, copper, galvanized, painted surfaces and other materials without damage. It is one of the few treatments that will not stain exterior wall when line drains outside



MARS NO.	DESCRIPTION	MARS PACK
93202	MARS TAB™ (100 tablets per bottle)	18

MARS One-Shot® Kits - 12 Applications Per Can

MARS One-Shot® is all it takes to instantly clear clogs. MARS One-Shot® drain opener kit instantly clears blockages in all types of fixtures and drains while simultaneously delivering a specially designed enzyme ingredient. This enzyme continues to dissolve grease buildup in the drain long after the initial blockage was cleared. The kit includes: One-Shot drain opener can 7 oz., three foot extension hose and twist fit adapter for ice markers and condensate drain pans.



Benefits & Features:

- Enzyme activated
- No ozone depleting chemicals
- Safe for sewers & septic systems
- Works instantly
- Sanitary and easy to use
- Universal adapter for all types of fixtures
- Seamless aluminum container will not rust
- For drains from 3/8" i.d. to 7/8 i.d.
- Made in the USA
- 12 applications per can

For Use On:

- Condensate pans
- Ice machines
- Bar sinks
- Toilets
- Bathtubs
- Kitchen sinks
- Shower drains
- Floor drains.
- Lavatories

MARS NO.	DESCRIPTION	MARS PACK
93220	MARS One-Shot® drain opener (7 oz.)	25
93221	MARS One-Shot® refill can (7 oz.)	36

Panseal

Seals and Restores Leaking and Rusted Drain Pans

Panseal is a unique multi-component 2 part epoxy designed to quickly and permanently seal, repair, and restore leaking and corroded drain pans. The product is available in caulk gun cartridges for easy application, gallon size containers for larger surfaces such as cooling towers, patch kits for vertical surfaces and single use 250 gram burst-seal bags. All contain pre-measured amounts of resin and hardener.

- Works in standing water
- Seals leaks immediately
- No surface preparation
- No system down time
- Works on both metal and plastic pans
- 100% solids and entirely free of solvents and volatile organic compounds



MARS NO.	DESCRIPTION	MARS PACK
93526	Panseal Cartridge	1
93527	Panseal Gallon	1
93528	Panseal Patch	1
93579	Panseal Bag, covers 2 sq ft	1
93500	Cartridge Nozzle	12

Circuit Protection

The ZBreaker set from Zebra Instruments protects systems that you install or service from damage caused by shorts, overheating, or wiring problems. A sticker is included so that, if the Tech desires, he can inform his customer where to press the "reset" button and possibly save a midnight service call.

The same circuit breakers now found on many high-end transformers and systems, but at a great price! Kit includes wires and pre-installed terminals that allow you to easily plug it in to the connectors where a plastic-type fuse existed. 3 Amp Size.

The Short-Pro Tool is a 24 volt system "short-finder". This helps the tech locate a control voltage short. A built-in automatically resetting circuit breaker turns on a bright red LED when tripped. As the tech removes the short, the breaker automatically resets, the LED goes out, and the circuit is restored. Lightweight and compact, with two 18" leads.



MARS NO.	DESCRIPTION	MARS PACK	CASE QTY.
08574	ZBreaker Set – 3A	1	24
08577	Short Finder Pro Tool	1	24

Accessories

MARS Digital Clamp On Meter

Features:

- AC Current
- DC/AC Voltage
- Resistance
- Continuity Check
- Continuity check buzzer sounds at approx. / 50 ohm max
- Peak Hold & Data Hold
- 1.3" (33mm) Clamp Jaw Opening
- Large 0.68", 3-1/2 digit LCD with low battery indicator
- Includes test leads, manual and carry case
- Overload protection provided for all ranges
- Meets IEC 1010 Safety Standard
- 9 volt battery included

Range: 0-600 A

Resolution: 1 A

Frequency: 50/60 Hz (+/- 1.5% rdg +/- 4 dgt)
40-400 Hz (+/- 2.5% rdg +/- 4 dgt)



MARS NO.	DESCRIPTION	MARS PACK
65749	Digital clamp-on meter	1

MARS Capacitor Tester

The MARS capacitor tester is a reliable precise 3-1/2-digit capacitance meter, which has 10 ranges. It is easy to use and is a very useful measurement tool.

Features:

- LCD display
- High accuracy
- Zeroing method: Adjust the "0 ADJ" knob
- Dual-slop integration A/D converter
- Over range indication: "1" shown on the display
- Operation condition: Temperature: 0°C~40°C (32°F~104°F)
Relative humidity: <75%
- 9V battery and test leads included
- Low battery indicator



Range	Resolution	Accuracy	Test Frequency
200pF	0.1pF	± (0.8% + 7)	800Hz
2000pF	1pF	± (0.8% + 5)	
20nF	10 pF	± (0.5% + 5)	
200nF	100pF	± (0.5% + 5)	
2 μF	1000pF	± (0.8% + 5)	80Hz
20 μF	0.01 μF	± (2.0% + 5)	
200 μF	0.1 μF	± (2.0% + 5)	8Hz
2000 μF	1 μF	± (2.0% + 5)	
20mF	10 μF	± (5.0% + 5)	

MARS NO.	DESCRIPTION	MARS PACK
65746	MARS capacitor tester	1

MARS Universal Remote Control for Mini-Split Units

MARS Universal Remote will operate with virtually any mini-split produced in any region of the world. Programming is accomplished by imputing your mini-split brand code or use the easy and intuitive self learn mode to set-up the remote to operate your mini-split. Operates with 2 AAA batteries.

- One touch function with LCD display
- Celsius or fahrenheit display
- Clock display
- 24 Hr. on/off timer for energy savings
- Displays room temperature
- Energy saver feature
- Automatically determines heat or cool mode



MARS NO.	DESCRIPTION	MARS PACK
65775	Mini-Split Universal Remote	1

MARS Volt Stick

The Volt Stick is an instrument for safely checking the presence of an AC voltage in cables, wall outlets, fuses, circuit breakers, junction boxes, power tools and appliances. Also, distinguishes between live and neutral wire in single or three phase supplies. No current flow is needed for correct operation of the Volt Stick. When a voltage is detected, a red indicator in the plastic tip of the Volt Stick illuminates. No contact is needed, unit operates at 1/8" distance from device.

Specifications

- Voltage range: 110 to 480 volts AC
- Not sensitive to stray electromagnetic static
- Response time: instantaneous
- Case breakdown: 4000 volts
- Operation temp: 0° to 120°F
- Batteries: two AAA, 1.5 volt alkalines included

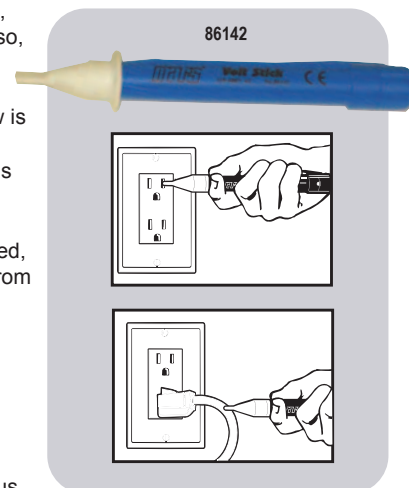

MARS NO.	DESCRIPTION	MARS PACK	CASE QTY.
86142	Volt Stick	1	12

Safety Power Adapters

Zebra'Dapter's provide visual indication of voltage levels before damage can occur. One is a fused power tap cordset & the other is a cheater cord used for a safer way to obtain and use 120V power. They are lighted to show the voltage level available, and if the indicator light is ignored, the fused circuit provides a last line of defense to protect you and your customer's equipment. These adapters are significantly a safer way to obtain 120V power.

MARS No. 08566 (Male end) has an in-Line fuse. (Two fuses included). Safer Power from Outlet to test Motors, Components & Systems

MARS No. 08567 (Female end) shows the voltage level at the plug. Used to check 120V power to run vacuum pumps, charging scales, drop lights, etc. lighting



Lighted Plug confirms Power

- No light means no power
- Normal light means 120VAC
- A brilliant light means you accidentally hooked it up to 240VAC

MARS NO.	DESCRIPTION	MARS PACK	CASE QTY.
08566	Fused Cheater Power Cord (male end)	1	12
08567	Fused Power Tap Cordset (female end)	1	12

MARS Test Leads - Pkg'd In Poly Bags



MARS NO.	CLIP SIZE	TYPE	CASE COLORS	WIRE SIZE	L	BAG QTY.
86070	Sm	Alligator	Wht, red, blk, yellow, grn	18	18"	10
86071	Med	Alligator	Red/blk w/boots	18	24"	2
86073	Lg	Alligator	Red/blk w/boots	14	24"	2
86074	Lg	Battery	Red/blk w/boots	16	36"	2

MARS Special Leads - Pkg'd In Poly Bags



MARS NO.	CLIP SIZE	DESCRIPTION	WIRE SIZE
86075	Med	6"-2 wire test cord w/red & blk insul. clips	16
86076	Med	24" - 3 wire test cord w/fem plug & 3 insul. clips	16

MARS Alligator & Battery Clips - Pkg'd in Zip Lock Bag

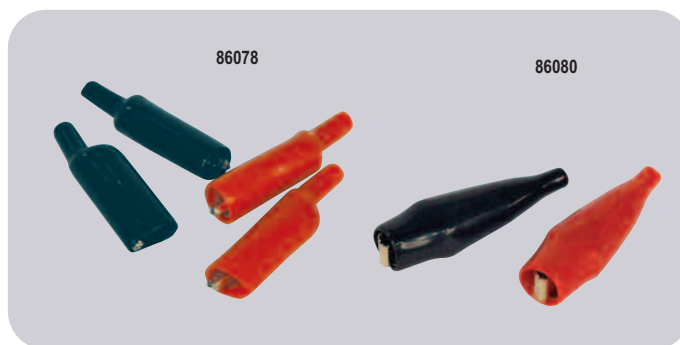

MARS NO.	CLIP SIZE	TYPE	DESCRIPTION	BAG QTY.
86078	Med	Alligator	Red/blk (1 ea. color boot - 2 clips)	1 pr.
86080	Med	Battery	Red/blk (1 ea. color boot - 2 clips)	1 pr.

Zebra Alligator Leads - Clamshell



MARS NO.	CLIP SIZE	TYPE	DESCRIPTION	BAG QTY.
08572	Sm	Alligator	5 different colors (up to 6A)	5
08573	Med	Alligator	8 different colors (up to 15A)	8

Accessories

Energizer Industrial Alkaline - Bulk

MARS and the Energizer Battery Company offer a complete line of alkaline, general purpose and lantern batteries. These high quality batteries are made in the U.S.A. and are competitively priced.

The Energizer Industrial Alkaline batteries are environmentally safe and are mercury-free, designed for long-lasting power in high drain, frequent use applications. Batteries are sealed and have excellent leakage resistance and a long storage life. This provides a better discharge rate, lower impedance and better low temperature performance than carbon zinc. These ZMA alkaline batteries are also less sensitive to changes in the discharge rate or duty cycle.



MARS NO.	DESCRIPTION	MARS PACK	CASE QTY.
79401	D cell - 1.5V	12	72
79402	C cell - 1.5V	12	72
79403	AA - 1.5V	24	144
79404	AAA - 1.5V	24	144
79405	9V	12	72

Energizer Batteries - Blister Pack



MARS NO.	DESCRIPTION	MARS PACK	CASE QTY.
79441	D cell - 2 pack	12	48
79442	C cell - 2 pack	12	48
79443	AA - 4 pack	12	48
79444	AAA - 4 pack	12	48
79445	9V - 2 pack	12	48
79457	AAA - 2 pack	6	6

Energizer Specialty Batteries



- Long lasting, reliable, miniature batteries
- Type: Silver Oxide
- Volt: 1.5



MARS NO.	DESCRIPTION	MARS PACK	CASE QTY.
79469	#357 1.5V, repl. 280-03, 280-08, 303/357, D303/357, SB-A9, SR 1154 SW, SR 44 SW, SR 44SW, SR44SW, WS14	6	480

Energizer Lithium Batteries



- Holds power for 8 years in storage
- Type: Lithium Coin
- Volt: 3



MARS NO.	DESCRIPTION	MARS PACK	CASE QTY.
79458	ECR2032BP 3V, repl. 5004LC, BR2032, DL2032, ECR2032, ST-T15	6	480
79454	CR1632, 3V, repl. BR1632, DL1632, ECR1632, KCR1632, KECR1632, KL1632, L1632	5	100

MARS Accessories

MARS NO.	DESCRIPTION	MARS PACK
79460	LR44, Batteries for 79479, 4 pk	1

MAGLITE® Flashlights



MARS and Maglite® are committed to providing a full selection of flashlight products designed for use by professionals. Features include anodized aircraft aluminum with knurled grip, o-ring sealed for minimum water resistance and adjustable beams from pinpoint spot to flood. All Maglite flashlights are designed and tested for high impact, precise illumination and longer use. All units have a limited lifetime warranty for repair and replacement of all internal and external components.



MARS NO.	DESCRIPTION	MAG. NO.	CASE QTY.
79205	Mini-mag AAA (black)	M3A016	12
79201	Mini-mag AA (black)	M2A016	12
79230	Mini-mag AA (blue)	M2A116	12
79202	AA combo pack (black)	M2A01C	12
79215	AA mag holster combo (black)	M2A01H	12

MAGLITE® Led Flashlights



MARS NO.	DESCRIPTION	MAG. NO.	CASE QTY.
79240	Maglite Pro 2AA LED (black)	SP2P01H	6

MAGLITE® Accessories



MARS NO.	DESCRIPTION	MAG. NO.	CASE QTY.
79222	AA nylon holster (black)	AM2A056	12
79226	AA leather holster (black)	AM2A026	12

MAGLITE® Replacement Lamps & Accessories



MARS NO.	DESCRIPTION	MAG. NO.	CASE QTY.
79223	AA/AAA bulb 2 pack	LM2A001	12

Upgrade LED Kits for MAGLITE®

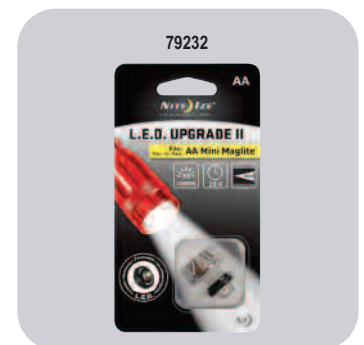

MARS NO.	DESCRIPTION	MAG. NO.	CASE QTY.
79232	AA LED Upgrade II-White	LRB2-07	6

Accessories

MARS Infra-Red Laser Thermometer

- Built-in laser pointer
- Data hold & Auto power off
- Temperature Range: -50°C to 350°C (-58°F to 662°F)
- Accuracy: ±2% of reading or ±2°C/±4°F • D:S=8:1
- Complete with 9V battery
- Quickly and easily take the surface temperature of any object. Just point, pull the trigger, and read the temperature on the display.
- °C / °F switchable button
- Backlit LCD display



MARS NO.	DESCRIPTION	MARS PACK	CASE QTY.
25580	Infrared thermometer	1	500

MARS Hand Held Scale

- Ideal for weighing and checking most gas and refrigerant cylinders
- Easy to use
- Push button for accuracy
- Auto shut off
- Max scale up to 55 lbs
- 9V battery included
- Accuracy up to +/- 2%
- LBS/KGS switch



MARS NO.	DESCRIPTION	MARS PACK
79039	Digital hand held scale	1

MARS Pocket Bi-Metal Dial Thermometers

MARS pocket dial thermometers consist of stainless steel cases with 5" stem. Thermometers are completely waterproof. Units are protected by flexible plastic case with clip. They can be recalibrated for accuracy.



MARS NO.	DESCRIPTION	MARS PACK	CASE QTY.
25510	1" dial-40° F to 160°F thermometer	1	12
25520	1" dial 0° F to 220°F thermometer	1	12

MARS Pocket Digital Thermometers

MARS #25531 deluxe digital pocket thermometer features an on/off switch and a data hold button. The easy to read LCD digits can be displayed in both fahrenheit and centigrade. The new slim design fits nicely in your pocket. Pocket clip and battery are included. $\pm 2^\circ$ accuracy. Uses MARS #79460 replacement battery. Water and drop resistant. Auto power off is also a new feature.



MARS NO.	DESCRIPTION	MARS PACK	CASE QTY.
25531	Deluxe digital pocket, -40°F to 300°F, -50°C to +150°C	1	12

MARS Refrigerator/Oven Thermometers

Horizontal refrigerator/freezer thermometer is most often specified for commercial applications. Hang, stand, or permanent mount. Stainless steel refrigerator or oven models utilize 2" easy to read dial. Hang or stand.



MARS NO.	DESCRIPTION
25540	Horizontal glass tube refrig. -40°F to 80°F, -40°C + 0° to +26°C
25542	Stainless steel refrigerator -20°F to 80°F, -29°C to +26°C

MARS Refrigerant I.D. Labels

MARS refrigerant I.D. labels are color coded to conform to each particular refrigerant. Each label specifies the type of refrigerant, the chemical name, the UN # and a space for the name and address of the cylinder owner. These self-adhering labels are 4 1/2" x 3 1/2", except for MARS #79528, Refrigerant Evacuation Certificate, which is 7 1/2" x 4 1/2".



MARS NO.	DESCRIPTION	MARS PACK
79522	R-22 Refrigerant I.D. Labels (10 pk)	1
79523	R-134A Refrigerant I.D. Labels (10 pk)	1
79516	R-404A SUVA® HP62 Refrig. Labels (10 pk)	1
79511	R-407A Refrigerant I.D. Labels (10 pk)	1
79512	R-407C Refrigerant I.D. Labels (10 pk)	1
79536	R-410A GENETRON® AZ-20 Refrig. Labels (10 pk)	1
79526	R-421A Refrigerant I.D. Labels (10 pk)	1
79525	R-422B Refrigerant I.D. Labels (10 pk)	1
79527	R-422D Refrigerant I.D. Labels (10 pk)	1
79506	R-438A Refrigerant I.D. Labels (10 pk)	1
79513	R-507 Refrigerant I.D. Labels (10 pk)	1
79528	Refrigerant evacuation certification (5 pk)	1
79609	R-427A Refrigerant I.D. Labels (10 pk)	1
79610	R-422C Refrigerant I.D. Labels (10 pk)	1
78996	R-449A Refrigerant I.D. Labels (10/pk)	1
78998	R-448A Refrigerant I.D. Labels (10/pk)	1

Accessories

MARS Plastic Anchor Kits

Plastic anchors are designed to be used with either woodscrews or sheet metal screws. They are recommended for quick, easy fastening of fixtures such as thermostats, thermostat guards, shelf brackets, cabinets, mirrors, pictures, etc. All plastic anchor kits include plastic anchor, screws and carbide masonry drill bit. All kits are packaged in a durable, see-through reclosable plastic storage case.



MARS NO.	DESCRIPTION	MARS PACK	CASE QTY.
79974	Plastic conical anchor with pan head combo kit contents: (100) 1/4 plastic anchors, (100) #10 x 1 pan combo hd screw zinc, (1) 1/4 x4 masonry drill	1	200
79975	Plastic conical anchor with hex washer head kit contents: (100) 1/4 plastic anchors, (100) #10 x 1 hex washer hd slot screws zinc, (1) 1/4 x4 masonry drill	1	200
79976	Plastic screw-in anchor with pan head combo kit contents: (50) plastic screw-in anchors, (50) #8 1 1/2 pan combo hd screw zinc	1	100
79977	Metal screw-in anchor with pan head combo kit contents: (50) metal screw-in anchors, (50) #8 1 1/2 pan combo hd screws zinc	1	100

Plastic Anchor Kits

Plastic anchors are designed to be used with either woodscrews or sheet metal screws. They are recommended for quick, easy fastening of fixtures such as thermostats, thermostat guards, shelf brackets, cabinets, mirrors, pictures, etc. All plastic anchor kits include plastic anchor, screws and carbide masonry drill bit. All kits are packaged in a durable, see-through reclosable plastic storage case.



MARS NO.	DESCRIPTION	CASE QTY.
80168	8-10 x 7/8" plastic anchor kit with slotted pan screw, contains: (100) 8-10 conical anchors, (100) 8 x 1" slotted pan screw, (1) 3/16" x 4" carbide masonry drill bit	1
80169	8-10 x 7/8" plastic anchor kit with pan combo screw, contains: (100) conical anchors, (100) 8 x 1" phillips/slotted pan screw, (1) 3/16" x 4"	1
80171	10-12 x 1" plastic anchor kit with slotted pan screw, contains: (100) 1/4" conical anchors, (100) 10 x 1 1/4" phillips, slotted pan screw, (1) 1/4" x 4" carbide masonry drill bit	1
80172	10-12 x 1" plastic anchor kit with hex washer slotted screw, contains: (100) 1/4" conical anchors, (100) 10 x 1 1/4" hex washer slotted screw, (1) 1/4" x 4" carbide masonry drill bit	1
80174	14-16 x 1 3/8" plastic anchor kit with slotted pan screw, contains: (50) conical anchors, (50) 14 x 1" slotted pan screw, (1) 5/16" x 4" carbide masonry drill bit	1

Hollow Wall Anchor Kits

Plastic anchors are designed to be used with either woodscrews or sheet metal screws. They are recommended for quick, easy fastening of fixtures such as thermostats, thermostat guards, shelf brackets, cabinets, mirrors, pictures, etc. All plastic anchor kits include plastic anchor, screws and carbide masonry drill bit. All kits are packaged in a durable, see-through reclosable plastic storage case.



MARS NO.	DESCRIPTION	CASE QTY.
80179	#6 hollow wall anchor kit, contains: (50) #6 hollow wall plastic anchors (50) 6 x 1" slotted phillips pan screw	1
80180	#8 hollow wall anchor kit, contains: (50) #8 self drill hollow wall plastic anchors (50) 8 x 1 1/4" slotted phillips pan screw	1

Tube Fitting Brushes - Heavy Duty Stainless Steel



MARS NO.	DESCRIPTION	MARS PACK
78801	1/4" OD 1/8" ID fitting brush (2 bag)	6
78802	3/8" OD 1/4" ID fitting brush (2 bag)	6
78803	1/2" OD 3/8" ID fitting brush (2 bag)	6
78804	5/8" OD 1/2" ID fitting brush (2 bag)	6
78805	3/4" OD 5/8" ID fitting brush (2 bag)	6
78806	7/8" OD 3/4" ID fitting brush (2 bag)	6
78808	1 1/8" OD 1" ID fitting brush (2 bag)	6
78809	1 3/8" OD 1 1/4" ID fitting brush (2 bag)	3

Tube Cleaning Brushes

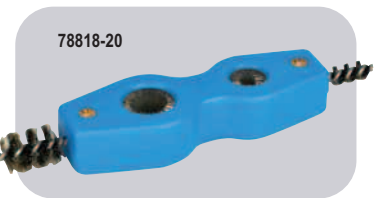

MARS NO.	DESCRIPTION	MARS PACK
78818	3/8" x 3/4" OD refrig. 4-1 brush tool	6
78819	1/2" x 3/4" OD refrig. 4-1 brush tool	6
78820	5/8" x 7/8" OD refrig. 4-1 brush tool	12

Refrigeration Coil Brush



MARS NO.	DESCRIPTION	MARS PACK
78828	5/8" to 1 5/8" fiber condenser cleaner 32"	12
78829	5/8" to 1 5/8" tapered condenser cleaner 29"	12
78830	3/4" to 1 5/8" tapered refrig. coil brush 28"	12

Fin And Coil Brushes

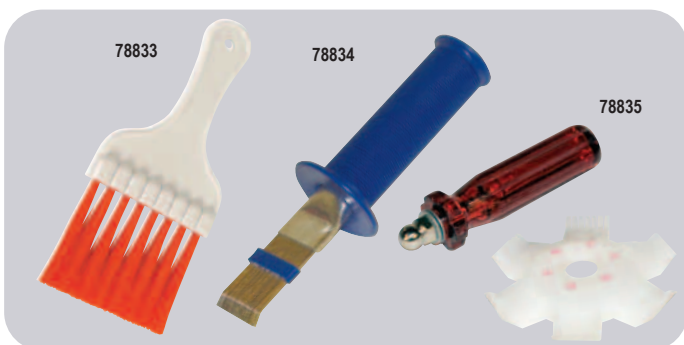

MARS NO.	DESCRIPTION	MARS PACK
78833	Fin and coil whiskbrush, 6 3/4"	12
78834	Fin and comb scraping tool, adjustable	1
78835	6-in-one fin comb (8, 9, 10, 12, 14, 15 fins per inch)	1

Acid And Flux Brushes

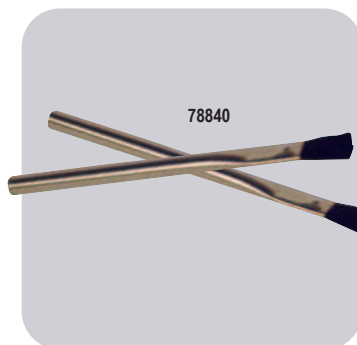

MARS NO.	DESCRIPTION	MARS PACK
78839	#1 acid brush 1/4" - 48 box	1
78840	#2 acid brush 3/8" - 48 box	1
78841	#1 acid brush 1/4" - 10 bag	10
78842	#2 acid brush 3/8" - 6 bag	10

Flue And Boiler Brushes

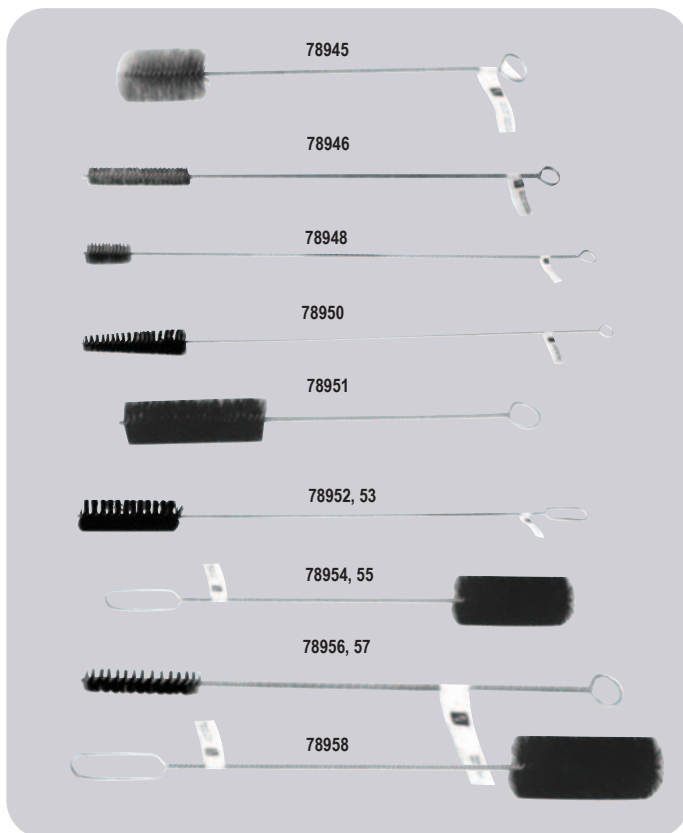

MARS NO.	DESCRIPTION	MARS PACK
78945	1-1/2" x 1-1/8", 30" OAL, Specialty Boiler Brushes - WEIL MCLAIN	6
78946	1/2" x 1", 27" OAL, Flat, Specialty Boiler Brushes - COLUMBIA	6
78947	2-1/4", 20" OAL, Tapered, Specialty Boiler Brushes - SLANT FIN	6
78948	1-1/2" x 1-1/8" x 36" OAL, HD, Gold Series Original, Specialty Boiler Brushes - WEIL MCLAIN	6
78949	1/2" - 1" Taper, 30" OAL, Horsehair, Specialty Boiler Brushes - TAPERED	6
78950	1-7/8" - 1-1/8" Taper, 42" OAL, Horsehair, Specialty Boiler Brushes - TAPERED	6
78951	1" Dia., 16" OAL, Horsehair Brushes for Boilers Burners, Radiators, Flues, Vents and Nozzles	6
78952	2" Dia., 27" OAL, Horsehair Brushes for Boilers Burners, Radiators, Flues, Vents and Nozzles	6
78953	3" Dia., 27" OAL, Tampico/Fiber Tube Brushes for Boilers Burners, Radiators, Flues, Vents and Nozzles	6
78954	2" Dia., 42" OAL, Horsehair Brushes for Boilers Burners, Radiators, Flues, Vents and Nozzles	6
78955	3" Dia., 42" OAL, Tampico/Fiber Tube Brushes for Boilers Burners, Radiators, Flues, Vents and Nozzles	6

These brushes have 3" brush lengths and 1/2" or 3/4" loop handles for easy hanging.

MARS NO.	DESCRIPTION	MARS PACK
78956	1/2" Dia., 18" OAL, Stainless Steel Fine-Wire Single Spiral Brushes for Small Boilers, Burners, Nozzles & Fans	12
78957	3/4" Dia., 24" OAL, Stainless Steel Fine-Wire Single Spiral Brushes for Small Boilers, Burners, Nozzles & Fans	12
78958	1-1/2" Dia., 42" OAL, Carbon Steel Fine-Wire Single Spiral Brushes for Small Boilers, Burners, Nozzles & Fans	6

Accessories

Applicator Brushes, Natural Bristle



MARS NO.	DESCRIPTION	MARS PACK
78902	1 1/2" economy paint brush-wood handle	36
78903	2" economy paint brush-wood handle	24
78904	2 1/2" economy paint brush-wood handle	12
78905	3" economy paint brush-wood handle	12

Utility And Appliance Brushes



MARS NO.	DESCRIPTION	MARS PACK
78910	Plastic handle stainless brush, 3 x 7 rows, 3 pk.	12
78911	Wood handle stainless brush, 2 x 9 rows, 3 pk.	12
78912	1 1/16" dia. parts cleaning brush	6
78913	Bent handle carbon scratch brush, 4 x 18 rows	12
78915	Shoe handle carbon scratch brush, 4 x 16 rows	12

Abrasive Cloth And Pads



MARS NO.	DESCRIPTION	MARS PACK
78920	1 1/2" x 5 yds. open coat white cloth	24
78921	1 1/2" x 10 yds. open coat white cloth	24
78922	1 1/2" x 25 yds. open coat white cloth	20
78923	1 1/2" x 5 yds. open nylon mesh cloth	24
78924	1 1/2" x 10 yds open nylon mesh cloth	24
78925	1 1/2" x 25 yds. open nylon mesh cloth	20
78926	4" x 6" med. nylon abrasive pad, maroon, 10 pk	1
78928	1 1/2" x 10 yds competitive abrasive cloth, Brown	1
78918	1 1/2" x 25 yds. competitive abrasive cloth, Brown	1

Accessories

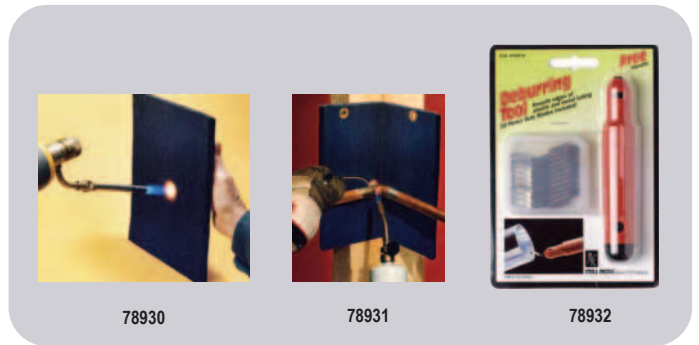

MARS NO.	DESCRIPTION	MARS PACK
78930	Solder/braze heat shield, 9" x 12" x 1/2" temperatures exceeding 2500°F	10
78931	Solder heat shield, 9" x 12" temperatures up to 2500°F	10
78932	Heavy duty deburring tool, 3 blades	10
78933	Deburring tool replacement blades, 5 pack	10

PowerCrown Outward Clinch Tackers



Model PC4000-OC1 & PC4000-OC2 Features:

- Easy squeeze design
- Compact, lightweight
- Convenient bottom load
- Unique design turns staple legs outward
- For pipe wrap, duct board and corrugated



MARS NO.	DESCRIPTION	MFG. NO.	CASE QTY
73349	Outward Clinch Tacker	T6-80C2	12
73347	3/8" Staples / 5M Box	STCR5019 3/8"	20
73350	1/2" Staples / 4M Box	STCR5019 1/2"	20
73351	9/16" Staples / 4M Box	STCR5019 9/16"	20

PowerCrown Outward Clinch Tacker - Model PC3000-OC2



Model PC3000-OC2 Features:

- Professional quality
- Drives 1/2" light wire Bostitch PowerCrown staples
- Powerful direct drive
- Unique design turns staple legs outward
- Convenient bottom load
- For pipe wrap, duct board and corrugated



MARS NO.	DESCRIPTION	MFG. NO.	CASE QTY
73343	Outward Clinch Tacker	T6-60C2	12
73348	1/2" Staples / 5.8M Box	STCR2619 1/2"	20

Channellock Pliers



For over a century Channellock has been the leader in manufacturing professional quality tools for all trades. All tools are made in the U.S.A. The MARS line of Channellock tools are housed in attractive merchandiser hang type style packaging to generate impulse sales and increase your profits.

Channellock pliers are hand honed perfectly matched cutters which are heat treated to hold their edge. These pliers are precision made of fine polished, high carbon drop forged steel and features blue plastic comfort grips.

The popular Tongue and Groove Pliers provide right angle teeth that grip in all directions for maximum bite and minimum wear. The undercut tongue and groove design assures the strongest non-slip jaw action and the patented PermaLock® fastener provides safer and smoother working than the old-time bolt and nut.

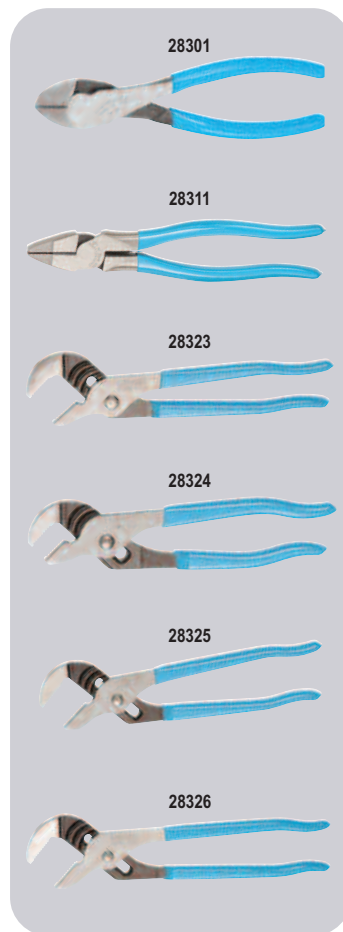

MARS NO.	DESCRIPTION	MFG. NO.	CASE QTY
28301	7" cutting plier - lap joint diagonal	337	20
28311	9" high leverage linemans plier	369	20
28323	9 1/2" Tongue & Groove Plier 5 Adjustments - 1 1/2" capacity	420	20
28324	6 1/2" Tongue & Groove Plier 5 adjustments - 7/8" capacity	426	20
28325	10" Tongue & Groove Plier 7 adjustments - 2" capacity	430	20
28326	12" Tongue & Groove Plier 7 adjustments - 2 1/2" capacity	440	20

Accessories

Fuse Pullers



MARS #25915, medium fuse puller is molded of tough, high impact nylon for greater strength. Handles with no-slip gripping surface, protective finger stops and yellow color are provided for extra safety.



MARS NO.	DESCRIPTION	MFG. NO.	MARS PACK	CASE QTY.
25915	7-1/4" medium puller for 0-100A fuses	34-016	1	10

Terminal Strips, 600V, 30a, UL & CSA



- Heavy duty corrosion resistant screws
- Rugged polyester thermo-plastic base
- Accepts wire sizes from 10 - 22AWG
- Operating temperature rated from 130°C to -40°C
- Recommended torque: 16 in. - lb.
- UL Recognized, CSA Certified



MARS NO.	DESCRIPTION	MFG. NO.	MARS PACK	CASE QTY.
25952	3 circuit terminal strip	89-203	1	10
25953	4 circuit terminal strip	89-204	1	10
25954	6 circuit terminal strip	89-206	1	10
25955	8 circuit terminal strip	89-208	1	10
25956	10 circuit terminal strip	89-210	1	10
25957	12 circuit terminal strip	89-212	1	10

Tap-Pak® Fish Tape



IDEAL Tape-Pak® fish tape reels and winders provide maximum strength and flexibility for fishing long runs of conduit. The case is built of high impact plastic that never dents or rusts. Use as a handle for pulling on fish tape to eliminate the dangers of bare-handed pulling as well as handy tape storage system. High grade tempered steel tape is fully protected and locked in reel when not in use so tape cannot kink spring free. Excellent for snaking long runs of thermostat wire.



MARS NO.	DESCRIPTION	MFG. NO.	MARS PACK	CASE QTY.
25849	50' fish tape - 8 1/2" dia.	31-033	1	1

Safe-T-Grip® Fuse Pullers



IDEAL's Safe-T-Grip® Fuse Pullers provide maximum efficiency and convenience when removing or replacing cartridge fuses. Constructed of fully insulated, reinforced, high-dielectric engineering plastic. Notched handles for a no-slip safe grip. Clearly marked amperage ranges. Moisture resistant...will not warp. Bright yellow in color.



MARS NO.	DESCRIPTION	MFG. NO.	MARS PACK	CASE QTY.
25911	5" midjet for fuses 9/32-1/2 dia.	34-001	1	1
25912	7 1/2" pocket for 0-100A fuses	34-002	1	10
25913	11 3/4" giant for 31-600A fuses	34-003	1	1

Wire Strippers And Crimpers



Preferred by professionals for over three decades and originated by IDEAL, these quality built T®-strippers feature built in wire cutters, looping holes, cushioned plastic grips and precision knife-type blades that give an accurate, easy strip every time. The multi-crimp tool provides excellent leverage for sure, easy crimping and cutting...even in close quarters. Crimps bare or insulated terminals and splices on wire sizes 10-22 AWG



MARS NO.	DESCRIPTION	MFG. NO.	MARS PACK	CASE QTY.
25701	T®-5 Stripper 10-18 AWG solid	45-120	1	10
25702	T®-6 Stripper 16-26 AWG strand	45-121	1	10
25703	T®-8 Stripper 8-16 AWG strand	45-124	1	10
25711	Multi-crimp Tool	30-429	1	5

Red Devil Putty Knives And Wall Scrapers

Red Devil offers professional high quality putty knives and wall scrapers. The black polypropylene comfort grip handles are shatterproof and solvent resistant for safety. Durable, high carbon, steel precision-ground blades extend through handles for maximum dependability. The blade has a mirror lacquered finish to prevent rust. Made in the U.S.A.



MARS NO.	DESCRIPTION	MARS PACK	CASE QTY.
93402	1 1/4" wide stiff putty knife	12	72
93403	1 1/4" wide flexible putty knife	12	72
93404	3" wide flexible putty knife	6	72

MARS 6-in-1 Super Driver

The MARS Super driver features a comfort grip handle. The soft easy grip promotes excellent torque. This six-in-one driver includes 3/16" & 1/4" slotted bits, #1 & #2 phillips bits and 1/4" & 5/16" nutdriver. These screwdrivers are packaged twelve per counter display box.



MARS NO.	DESCRIPTION	MARS PACK	CASE QTY.
25984	MARS 6-in-1 super driver	12	12

Magnetic Nut Setters

- Features a magnet with enhanced holding to help improve fastening



MARS NO.	DESCRIPTION	CASE QTY.
21620	1/4" mag nut setter 2 9/16"L (1/cd)	96
21621	5/16" mag nut setter 2 9/16"L (1/cd)	60
21627	1/4" mag nut setter 6"L (1/cd)	72
21628	5/16" mag nut setter 6"L (1/cd)	72

Superior Tool Mini Hacksaw And Blades

- Cuts wood, plaster, steel, brass, etc...
- Cushioned handle

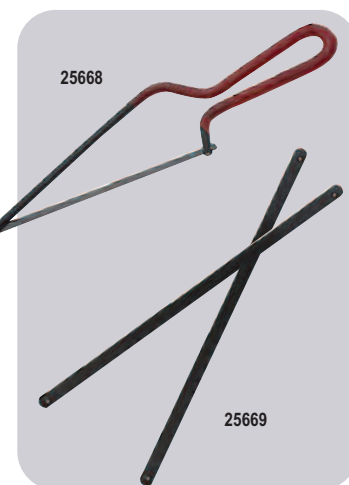

MARS NO.	DESCRIPTION	MARS PACK	CASE QTY.
25668	10" mini hacksaw,	1	6
25669	6" high carbon steel repl. blades (10/card)	1	6

MARS Smoke Candles

- Quickly and efficiently produce dense white smoke
- Classic smoke provides the best results, allowing you to locate difficult leaks at greater distance
- Disposable and easy to use



MARS NO.	DESCRIPTION	CASE QTY-
79534	4000 cu. ft. smoke, 30 seconds	12
79535	8000 cu. ft. smoke, 1 minute	12

Cotton/Jersey Gloves



MARS NO.	DESCRIPTION	MARS PACK	CASE QTY-
79151	9 oz. brown jersey glove/individual pack	1	12
79153	Fleece lined cotton jersey/individual pack	1	12

Leather Gloves



MARS NO.	DESCRIPTION	MARS PACK	CASE QTY-
79157	Leather palm safety cuff/individual pack	1	12
79166	Grain cowhide leather	1	12

PVC/Nitrile/Neoprene Gloves



MARS NO.	DESCRIPTION	MARS PACK	CASE QTY-
79145	PVC long gauntlet cuff gloves	1	12

Black Mamba Gloves

- Made with a patented NITREX® polymer
- Super strong (6.0 mils) powder free nitrile glove
- 3 times the chemical and puncture resistance of a comparable thickness latex or vinyl glove
- Grip rite finish for secure handling.



MARS NO.	DESCRIPTION	MARS PACK	CASE QTY-
79200	Black Nitrile Gloves – L 100/box	1	10
79138	Black Nitrile Gloves – XL 100/box	1	10

Goop Hand Cleaners

For nearly 50 years, Goop has been the only name you need to know in hand cleaners. It's a name that wholesalers and contractors alike know and trust. Goop is non-toxic and biodegradable. Goop will remove almost anything...from almost everything. Use Goop to clean the dirtiest, greasiest hands. Use it for other tough cleaning jobs as well, such as removing stains from washable clothing, cleaning vinyl, plastic, canvas, floor tile - or whatever else gets dirty.



MARS NO.	DESCRIPTION	MARS PACK
93150	14 oz. can	12

Orange Goop Hand Cleaners

For customers who want a fresh orange scent in a tough, natural liquid hand cleaner, get the Orange Goop. There are no harsh solvents - just natural citrus. Available in regular or pumice formula. Biodegradable, too. Orange Goop...just another example of how we're giving today's contractors what they want.



MARS NO.	DESCRIPTION	MARS PACK
93157	14 oz. can	12
93160	16 oz. liquid squeeze bottle	12
93163	16 oz. liquid squeeze bottle w/ pumice	12

Scrubs in-a-Bucket™

Scrubs in-a-Bucket™ provide fast, easy and effective hand cleaning with portability. Can be used anywhere, anyplace, anytime on the toughest soils, greases, tar, graphite...even printers ink. Each dispensing canister contains 10 1/2" x 12 1/4" perforated high-strength absorbent cleaning towels, treated with a gentle-to-the-skin but effective heavy duty grease cutting and soil lifting formulation. Pumice performance, without the messy, gritty pumice! Leaves skin lotion-soft, with a natural citrus fragrance. Contains germ fighting Triclosan. No rinsing, no drying, no residue. Also ideal for cleaning tools, work in process and for spills.



MARS NO.	DESCRIPTION	MARS PACK	CASE QTY.
93201	Scrubs in-a-Bucket™ (72 towels)	6	42
93203	Scrubs in-a-Bucket™ (30 towels)	6	72

MARS Maintenance Products

- Stops squeaks
- Removes and protects
- Loosens rusted parts
- Frees sticky mechanisms
- Smart straw helps to get into hard to reach areas
- Drives out moisture



MARS NO.	DESCRIPTION	MARS PACK	CASE QTY.
79036	WD-40 8 oz. spray smart straw	12	24
79037	WD-40 11 oz. spray smart straw	12	12

Accessories

Kimberly-Clark Disposable Wiper/Towels

Kimberly-Clark is durable for demanding jobs. Strong, even when wet. This 4-ply tissue wiper traps dirt and absorbs liquids quickly. Made with 100% recycled paper.



MARS NO.	DESCRIPTION	MARS PACK	CASE QTY.
79105	WYPALL X60 Cloths, White, 126 pop up™ box, 9.1 in. x 16.8 in	1	10

MARS Shop Towels

MARS shop towel rags are 100% cotton material. This 15" x 15" red cloth towel is extra absorbent and ideal for cleaning up grease on tools or machinery. Long lasting and machine washable. Hemmed edges.

The MARS 100% cotton terry towel is an all purpose, white terry cloth towel that can be used for drying, polishing, dusting and waxing.



MARS NO.	DESCRIPTION	MARS PACK	CASE QTY.
79025	White terry towel (12 pack)	1	12
79026	Red cloth shop towel (12 pack)	1	18
79027	Red cloth shop towel (50 pack)	1	6

32 oz. Spray Bottle

- Polypropylene sprayer
- Nitrile O-ring and seating cup
- 3 finger trigger for comfort



MARS NO.	DESCRIPTION	MARS PACK
79009	32 oz. Spray Bottle	12

Blue Huck Towels

- Excellent absorbency!
- 5 lb. box
- Lint free
- Prewashed
- Approx. 22" x 13"
- 30-35 towels in box



MARS NO.	DESCRIPTION	MARS PACK
79024	Blue Huck Towels	1

MARS Micro Fiber Cloth Towels

- Quick drying, super soft and non-abrasive
- Lint free
- Super absorbent
- Very economical
- Use wet or dry
- Machine washable
- Wash separately in cool water; dry low heat or air dry
- Size: 12" x 16"



MARS NO.	DESCRIPTION	MARS PACK
79196	Micro Fiber Cloths All Purpose, Assorted	12

HVAC RTV Silicone Sealant

HVAC RTV Silicone Sealant is a superior quality silicone which remains flexible from -40°F to 350°F. Never dries out. Has excellent adhesion to metals and can be used for virtually every HVAC need.

- Cures to 100% silicone rubber
- Resistant to sunlight and weather extremes
- Fast cure, high strength
- Meets the requirements of FDA Regulation No. 21 CFR 177.2600
- Meets the requirements of NSF Standard 51
- Listed by Underwriters Laboratories (UL Listed)



MARS NO.	DESCRIPTION	MARS PACK	CASE QTY.
93249	Silicone sealant clear	10.1 oz.	12
93251	Silicone sealant white	10.1 oz.	12
93252	Silicone sealant gray	10.1 oz.	12
93253	Silicone sealant clear	2.8 oz.	12
93254	Silicone sealant white	2.8 oz.	12

Heat Resistant Silicone

HVAC/R RTV Hi-Temp Silicone Sealant Red is a superior quality silicone which was formulated to perform at temperatures ranging from -40°F to 500°F (-40°C to 260°C) for continuous operation and 550°F (288°C) for intermittent exposure. These features make HVAC/R RTV Hi-Temp Silicone Sealant Red ideal for use around furnace vent pipes, restaurant hoods and heat exchangers. Used where critical bonding and sealing parts must perform at high temperatures.

- Cures to 100% silicone rubber
- Resists the effects of sunlight and weather extremes
- Fast cure, high strength



MARS NO.	DESCRIPTION	MARS PACK	CASE QTY.
93255	Hi-Temp. silicone red	10.1 oz.	12
93247	Heat resistant silicone red	2.8 oz.	12

12-1 Seam Sealer

Ruscoe's 12-1 seam sealer is recommended for sealing openings less than 1/8 inch. It can be used as an effective sealant against water, chemicals, air and dirt for sealing seams in gutters, downspouts, roof and chimney flashings, animal feeders and troughs, wood, concrete, ceramic, brick, metal, stone, masonry, marble and glass. Ruscoe's 12-1 seam sealer is recommended for sealing horizontal seams only.

- Aluminum fortified adhesive formula
- Excellent adhesive properties
- Excellent exterior durability and flexibility
- Can be applied at low temperatures
- Requires no primer
- Good adhesion to either porous or non-porous substrates—including glass
- Weatherproof—skins over to form a protective seal



MARS NO.	DESCRIPTION	MARS PACK	CASE QTY.
93504	12-1 Seam Sealer, 10.3 Fl Oz	1	24

Fire Stop Caulk

Red Devil Fire Stop Caulk effectively seals penetration openings against the spread of fire, smoke, toxic gases and water when applied properly.

- A Latex-based, high-solids Fire Stop compound
- No Shrinkage
- Withstands temperatures up to 2000° F and is up to 4 hour fire rated
- Sandable and Paintable
- Meets Fed. Specs ASTM E-814 (UL 1479) and ASTM E-84 (UL 723) and many UL Classifications



MARS NO.	DESCRIPTION	CASE QTY.
93293	Firestop Caulk, 10.5 FL Oz.- Red	12

Red Devil Celulon And Acrylic Caulk

Celulon™ plumbing and HVAC adhesive sealant is sometimes preferred over silicone. This easy to apply adhesive sealant adheres to all substances, is paintable, cleans up with water and has no offensive odor. Used to seal A/C ducts and lines. Application temp: 40 ° to 90°F. Service temp: -25° to 200°F.



MARS NO.	DESCRIPTION	MARS PACK	CASE QTY.
93256	Celulon HVAC sealant clear	10.1 oz.	12
93257	Celulon HVAC sealant white	10.1 oz.	12

Red Devil Butyl Sealants

Red Devil's butyl sealant is a high performance rubber-like sealant that is ideal for tough outdoor jobs and below grade applications. (marine usage above waterline) It can be used wherever watertight seal is required. This paintable sealant provides excellent adhesion to most building surfaces including aluminum, stone, wood, brick, fiberglass, plastic, metal, etc. This sealant is ideal for use on window/door frames, aluminum gutters, chimney roofs, concrete foundations etc. Sealant remains rubbery and flexible from 0°F to 225°F after full cure.



MARS NO.	DESCRIPTION	MARS PACK	CASE QTY.
93290	Butyl sealant white	10.1 oz.	12
93291	Butyl sealant aluminum gray	10.1 oz.	12

Accessories

Red Devil Specialty Products

Red Devil's blacktop & roof repair is water resistant and stays flexible. This butyl rubber asphalt sealant adheres to cinder block, wood asphalt, concrete, brick and metal. Use on blacktop driveway cracks, chimney flashings, shingles & skylights. Apply at temperatures between 10°F & 100°F. Full cure in 72 hours

Red Devil speed demon latex caulk is a general purpose caulk that applies easily, dries quickly is paintable and won't stain or bleed.



MARS NO.	DESCRIPTION	MARS PACK	CASE QTY.
93244	Blacktop & roof repair black 10.1 oz.	12	12
93265	Speed demon latex caulk white 10.1 oz.	12	12

Insulating Foam Sealant

Insulating Foam Sealant is a polyurethane-based sealant that fills, air-seals and insulates small gaps (less than 1 inch). Easy to use with the straw applicator and expands to take the shape of cracks and voids to form a durable, airtight, water-resistant bond that eliminates unwanted airflow and helps reduce condensation.

- Exceptional adhesion to building materials
- Interior or exterior use
- Tack free in 6 minutes; Trims in 30 minutes
- Foam elasticity allows for movement/shifting within a structure
- Paintable, stainable and sandable
- Cream colored foam
- Cures rigid
- All-direction dispensing
- UL Classified



MARS NO.	DESCRIPTION	MARS PACK	CASE QTY.
93268	Foam sealant 12 oz.	12	12
93267	Foam sealant 24 oz.	12	12

Fireblock Foam Sealant

Fireblock Foam Sealant inhibits the spread of fire and smoke. The long-lasting, airtight, weather-resistant foam adheres to wood, metal, masonry, glass, and most common building materials. The code orange foam is easily identifiable for inspections and seals service penetrations between floors and electrical runs through wall studs.

MARS NO.	DESCRIPTION	MARS PACK	CASE QTY.
93195	Fireblock Foam Sealant Orange 12 FL Oz	12	12

MARS Duct Seal Putty

MARS Duct Sealing Putty is a non-hardening, non-toxic, gray putty compound used for countless applications in the refrigeration, heating and cooling, electrical trade, and plumbing fields. It can be shaped by hand to any form, and reused if necessary, for plugging openings through foundations, sealing around electrical boxes, refrigeration tube entry and so much more. Temperature range: 25°F to +120° F.



MARS NO.	DESCRIPTION	MARS PACK	CASE QTY.
93520	1 lb. slug - boxed	1	10
93521	5 lb. slug - boxed	1	10
93522	2 lb. slug - boxed	1	10

Caulking Guns

For your convenience, MARS also offers easy to load and operate caulking guns. Guns hold the standard 10.3 oz. cartridges. MARS #93269 skeleton gun is ideal for large jobs. This heavy duty but light weight unit saves time in loading for the busy contractor. The professional skeleton gun, MARS #93278, offers three times more thrusting power with a smooth rod parallel frame. The professional ratchet type caulking gun, MARS #93279, is a professional conventional type gun recommended for sealants from light to heavy consistencies.



MARS NO.	DESCRIPTION	MARS PACK	CASE QTY.
93269	Skeleton caulking gun	1	24
93278	Professional skeleton caulking gun	1	12
93270	Econo conventional caulking gun	1	24
93279	Professional ratchet caulking gun	1	24

- B2 Fire Rating
- Long-lasting, airtight, weather-resistant seal
- Adheres to wood, metal, masonry, glass, and most common building materials
- UL classified
- No CFCs or HCFCs



MARS Cork Tape - 1/8"x 2"x 30' Roll

MARS Cork Tape is ozone resistant and specially designed for all types of climate. It insulates cold pipes for all kinds of air conditioners, freezers, and refrigerators. Cork Tape helps stop condensation problems. It is ideal for retarding heat gain in cold pipes and prevents heat loss in hot pipes. Can also be used for gasketing purposes. MARS Cork Tape sticks to all kinds of dry metals. This flexible tape seals tightly without drying. Temperature range: -20°F to 200°F / -29°C to 93°C.

Corktape is made from virgin cork specially imported from Portugal & Spain and has the following characteristics:

1. Compared to other cork tapes - our cork tape features rubber/asphalt & 100% virgin cork instead of asbestos / saw dust as used by other manufacturers.
2. The width is always 2" wide unlike other brands where size varies from 1-3/4" - 2".
3. Very good adhesion property. It sticks on the metal pipe tightly and does not come out in one piece if unwrapped.
4. A wide service temperature range -29° F - +200°F
5. Once installed the outer surface dries creating a shield against unwanted dust and dirt while the inner side remains wet. So even after a year or two, the user can remove the cork tape and reapply elsewhere without any change in the properties of the tape. Other brands such as Prestite/Virgin are mostly wet outside and inside making it vulnerable to dust and dirt which eventually deteriorates its insulation properties.



Physical properties:

Composition:
Polymer based material containing synthetic rubbers, asphalt and approximately 50% cork by volume. It has a grainy rubber-like consistency and contains no asbestos.

Solid Contents:
99.8%

Color:
Black

Thermal Conductivity:
0.60 BTU/hr /ft²/F/in at 75°F

Moisture / Vapor Transmission:
0.02 perms.
(ASTM E-90 Procedure C)

Water Absorption:
0.01% by volume
(ASTM D-1056)

Ozone Resistance:
Good

Thickness To Prevent Pipe Condensation

Ambient Temperature & %RH	Pipe Temperature	
	50°F (10°C)	32°F (0°C)
77°F (25°C) & 50% RH	Double Layer	Triple Layer
85°F (29°C) & 70% RH	Double Layer	Triple Layer
	plus Double Layer	Plus Triple Layer

MARS NO.	DESCRIPTION	MARS PACK	CASE QTY.
93505	Cork Tape	1	10

MARS Foam Tape - 1/8"X 2"X 30' Roll

MARS Foam Tape is a self-adhering closed cell thermal insulation tape. This flexible tape is ideal for wrapping hot or cold pipings and fittings. The energy saving and very easy to use Foam Tape is excellent for preventing condensation problems. MARS Foam Tape is designed for retarding heat loss in hot pipings and preventing heat gain or frost formation on cold, chilled water pipings or refrigerant lines. Adheres firmly to all metals. Temperature range: -20°F to 200°F / -29°C to 93°C.



1. Good weather and UV resistant - reason being EPDM (Ethylene Propylene Diene Monomer) is the main compound in the manufacturing of Foamtape. In practice EPDM is also used in the manufacturing of glass window strips of cars, which lasts for more than 10 years outdoors without any replacement (inspite of being exposed to rain, heat & cold).
2. The specially coated acrylic adhesive provides extra adhering strength compared to other tapes. Once installed, the special adhesive will act as the bonding agent and won't let the tape delaminate.
3. Low thermal conductivity (0.26 BTU. in/sq. ft. hr. deg. F at 75°F) to prevent heat loss/heat gain and save energy.
4. An ozone friendly product manufactured under strict supervision of trained personnels with quality check at every production point.
5. Low halogen contents. Tests have proved that MARS Foam Tape (or FOAMTAPE excluding the adhesive) has chlorine and bromine content of 4.36% and 1.35% compared to NBR/PVC (Armstrong, Rubatex) based brand insulation which has 12.45% and 6.14% respectively.
6. Our vulcanization system uses negligible amount of Sulphur (chemical which corrodes copper tubings) and this special vulcanization process decomposes chemicals almost completely.

Physical properties:

Composition:
Closed cell, elastomeric thermal insulation.

Color:
Black

Density:
6±1 pounds per cubic feet.
(0.09-0.12 g/cm³)
(ASTM D-1667)

Thermal Conductivity:
0.26 BTU in./ft² hr. °F at 75°F
(0.04 W/mK at 24°C)
(ASTM C-177)

Water Absorption:
Max 5% by weight
(ASTM D-1056)

Water Vapor Permeability:
0.15 Perm-inch (ASTM C-355)

Temperature Range:
-20°F (-29°C) to +200°F (+93°C)

Thickness To Prevent Pipe Condensation

Ambient Temperature & %RH	Pipe Temperature	
	50°F (10°C)	35°F (0°C)
80°F (27°C) & 50% RH	Single Layer	50% Overlap
85°F (30°C) & 70% RH	50% Overlap	50% Overlap
	plus Single Layer	Plus 50% Overlap

MARS NO.	DESCRIPTION	MARS PACK	CASE QTY.
93506	Foam Tape	1	12

Accessories

Mortite Pipe Wraps

Mortite's no-drip® tape stops cold water pipe sweating permanently. Won't dry out, crack or shrink. This self-adhering tape insulates hot water pipes up to 160°F. No-drip® tape molds around valves, joints, tees and irregular fittings. The 2"W x 30'L roll covers 30 lineal feet of 1/2" O.D. pipe. Provides clean, neat appearance.



MARS NO.	DESCRIPTION	CASE QTY.
93516	No-drip® tape - 2" x 30' roll	10

Mortite Weather Stripping Products

MARS #93507, air conditioner window seal, seals the gap between window sill and air conditioner. This permanent, all season foam strip prevents heat loss in winter, cooling loss in summer. Attractively packaged in a colorful poly bag for pegboard merchandising.

Mortite's closed-cell foam tape, MARS #93509 seals better in hot and cold climates. This durable vinyl tape stands up to extreme cold temperatures and will not freeze. Closed-cell means the cells prevent air from passing through the weatherstrip tape and won't absorb moisture. Self adhering, seals out drafts, dust and insects better than open-cell tape. MARS #93509 cushions and eliminates noisy vibrations around storm windows, A/C's and small appliances.



MARS NO.	DESCRIPTION	CASE QTY.
93507	Foam strip - 1/4" x 1-1/4" x 42"L	12

Mortite A/C Foam Filter

Mortite's air conditioner filter helps to keep the room free from outside dust and dirt while increasing efficiency. This polyurethane foam filter is easy to install. And the 15" x 24" size can be cut to fit all window and through-wall air conditioners. Easy to clean - requires only regular detergent and water. Reusable.

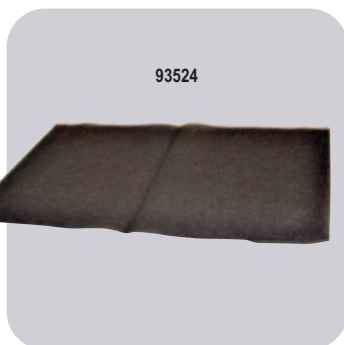

MARS NO.	DESCRIPTION	CASE QTY.
93524	Foam filter - 15" x 24"	24

Cloth Duct Tapes

Heavy duty cloth duct tape for use in high performance applications

- Excellent holding power
- Withstands extreme temperature fluctuations
- Waterproof backing
- Applicable Standards: FSI 15/SDI 40; UL 723

Premium grade cloth duct tape combines high tensile strength, excellent holding power and conformability to deliver a tape solution that can withstand the rigors of the job.

- Excellent holding power
- High tensile strength
- Conformable
- Waterproof backing
- Applicable Standards: FSI 10/SDI 10; UL 723

Performance grade cloth duct tape for use in the HVAC industry offering extremely aggressive adhesion, good conformability to a variety of surfaces, and performs well in warm or cold climates.

- Cold temperature adhesion
- Excellent holding power with good conformability
- Waterproof backing
- Applicable Standards: FSI 0/SDI 0; UL 723

All-purpose grade cloth duct tape conforms well to a variety of surfaces, tears easily by hand and will not twist or curl during application for ease of use.

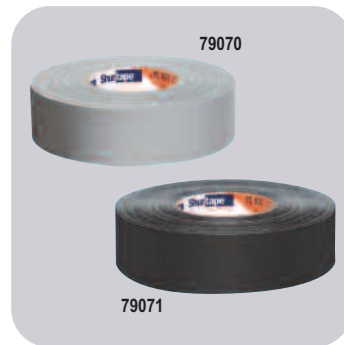

MARS NO.	DESCRIPTION	SIZE	MARS PACK
79070	Heavy Duty cloth tape, silver	2" x 60 yds.	24
79071	Heavy Duty cloth Tape, black	2" x 60 yds.	24
79072	Premium grade, silver	2" x 60 yds.	24
79074	Performance grade, silver	2" x 60 yds.	24
79075	Performance grade, black	2" x 60 yds.	24
79077	Performance grade, silver	2" x 60 yds.	24
79088	All Purpose, black	2" x 60 yds.	24

MARS Foil Duct Tapes

Mars #79081 and 79082 are dead-soft aluminum foils with aggressive adhesive properties.

UL 723 tested Foil/Scrim/Kraft (FSK) tape for sealing seams in scrim-reinforced duct insulation. Ideal for applications that demand a maximum-strength tape, AF 984CT is lined, offers an acrylic adhesive and can be used in temperatures ranging from -20 F to 260 F.

- Superior stability during extreme fluctuations in temperatures
- Wrinkle-free backing resists tearing
- Resists water vapor and smoke transmission
- Applicable Standards: FSI 5/SDI 0; UL 723



MARS NO.	DESCRIPTION	SIZE	MARS PACK
79081	Aluminum foil tape	2" x 50 yds.	24
79082	Aluminum foil tape	3" x 50 yds.	16
79083	Foil scrim kraft tape	2" x 50 yds.	24
79084	Foil scrim kraft tape	3" x 50 yds.	16

U.L. Listed Tapes

UL 181A-P/B-FX Listed aluminum foil HVAC tape for joining and sealing joints. A tape that "does it all," AF 100 is engineered to form airtight bonds on joints and seams in application temperatures ranging from -20 F to 260 F and in humid conditions.

- Printed aluminum foil tape
- Excellent adhesion to rigid fiberglass duct board and flexible air duct
- Flexible and easy to use to create airtight bonds
- Superior stability during extreme fluctuations in temperature
- Applicable Standards: Tested in accordance with UL 723; FSI 25/SDI 50; UL 181A-P/B-FX Listed; US Green Building Council – LEED® Point contributor product



MARS NO.	DESCRIPTION	SIZE	MARS PACK
79087	U.L. 181 foil tape	2 1/2" x 60 yds.	16

Spray Adhesive

MARS #79094 is especially designed to bond polyethylene to itself, concrete block, wood and other hard to bind surfaces. Does not contain methylene chloride. Very quick, aggressive tack. Excellent for HVAC insulation applications.



MARS NO.	DESCRIPTION	MARS PACK
79094	Spray adhesive, 17 fl. oz.	12

Liquid Electrical Tape

- Forms an airtight, protective, waterproof, UV resistant, dielectric coating
- Will not peel or unravel
- Patented, UL-tested, fast drying formula



MARS NO.	DESCRIPTION	MARS PACK
86135	Liquid electrical tape (black), 4oz.	1

PVC Electrical Tape

PVC electrical tape provides excellent adhesion to aluminum and copper conductors and plastic and rubber insulations where quick identification is most needed. Due to its primary use in low temperatures, it can be stretched to conform to any shape without breaking. UL listed and CSA approved. PVC electrical tape is designed for general splicing and as a protective outer jacket. Flame retardant and cold and weather resistant. UL listed and CSA approved.

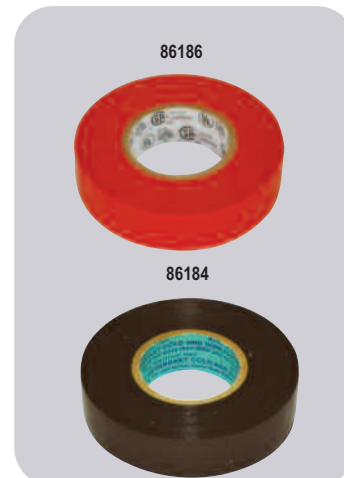

MARS NO.	DESCRIPTION	MARS PACK	CASE QTY.
86186	3/4" x 66' - red	1	100
86187	3/4" x 66' - white	1	100
86188	3/4" x 66' - green	1	100
86189	3/4" x 66' - blue	1	100
86184	3/4" x 66' - black	1	100
86133*	3/4" x 60' - black	10	100

* Non-UL

Low Density Thread Seal Tape



- Thickness 3 mills.
- Standard grade, low density
- Provides a highly resistant seal on pipe threads for all types of service
- Suitable for use with solvents, chemicals, oxygen, and on food lines
- Non-toxic
- Permits easy disassembly, even after years of service
- Meets Mil. Spec. T-27730A
- Sealing temperature range: -450°F to 550°F (-268°C to 288°C)
- Working pressures: 2,000 PSI (136 BAR)
- Sold in case quantities only



MARS NO.	DESCRIPTION	CASE QTY.
95409	1/2" x 260"	144
95410	1/2" x 520"	144
95412	3/4" x 520"	144

Accessories

High Density Slick-Tite® Thread Seal Tape



- Thickness 3 mils.
- High density
- Provides a highly resistant seal on pipe threads for all types of service
- Made in USA
- Suitable for use with solvents, chemicals, oxygen, and on food lines
- Non-toxic
- Permits easy disassembly, even after many years
- Meets Mil. Spec. T-27730A
- Sealing temperature range: -450°F to 550°F (-268°C to 288°C)
- Working pressures: 2,000 PSI (136 BAR)



MARS NO.	DESCRIPTION	MARS PACK
95527	1/2" x 300"	12
95528	1/2" x 600"	12
95530	3/4" x 300"	12

MARS Standard Grease Fitting

Standard grease fittings are precision engineered to withstand rugged use in most automotive and industrial applications. The feature steel fittings with corrosion resistant plated finish and built-in ball check.

The small grease fitting assortments contain the three most popular 1/4"-28 threaded fittings used when making a "change-over" from plugs to fittings. Ideal for the contractor.



93383 Standard fitting assortment includes:

Qty.	Description	Thread
4	short-straight	1/4"-28
2	short 45°	1/4"-28
2	short 90°	1/4"-28

MARS NO.	DESCRIPTION	MARS PACK	CASE QTY.
93376	1/8" npt, short-straight fitting, 10/card	11-151	1
93378	1/8" npt, short 45° fitting, 5/card	11-159	1
93383	8 assorted grease fitting kit	11-955	1

MARS PTFE Thread Sealant Tapes

- PTFE Standard grade white thread seal
- 3000 PSI rating
- Temperature range: -450°F to +500°F
- Combustion: does not support combustion

MARS No. 78944 - yellow gas PTFE thread sealing tape is designed specifically for natural gas, propane and butane lines. Just 3 wraps for leak-proof joints.



MARS NO.	DESCRIPTION	MARS PACK
78940	1/2" x 260" - STD grade white PTFE thread sealant tape	12
78941	1/2" x 520" - STD grade white PTFE thread sealant tape	12
78942	1/2" x 260" - hi-density red PTFE thread sealant tape	10
78944	1/2" x 260" - hi-density yellow (UL) gas tape	10

Hercules Megatape

- Provides a clean, positive seal on threaded connections
- More PTFE to seal better with fewer wraps
- For threads up to 1-1/2 in. diameter
- High density 3.5 mil thickness
- Use on - Plastic, brass, copper, aluminum, stainless steel, galvanized steel or black iron piping
- Seals on a huge variety of threaded systems
- Perfect choice for Plumbing Professionals
- NOT FOR USE WITH LINES CARRYING OXYGEN



MARS NO.	DESCRIPTION	MARS PACK
73149	1/2in x 1000, Gray	1

MARS Funnels

MARS No. 93396 Plastic Utility funnel is durable, oil and gas resistant. Safe for all petroleum products, complete with handy storage hanging tab. 16 oz capacity, 5-1/2" H x 6" Dia., 3/4" OD tip.

MARS No. 93397 Polyethylene All Purpose Utility funnel is rugged, corrosion-resistant with fine mesh straining screen and handy hanging tab. 2 quart capacity, 9" total height, 7" diameter, 1" OD tip.

MARS No. 93398 Utility Funnel with Screen is the most popular all-purpose fluid dispenser. Galvanized steel. Includes screen and 12" flexible extension with tapered tip. Tip 4/16" OD / 9/16" ID.

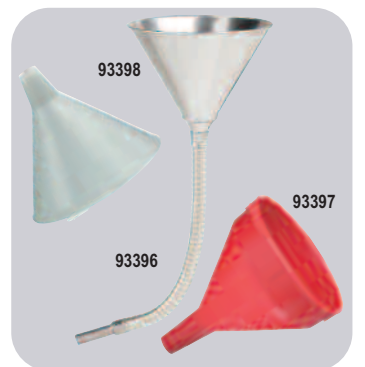

MARS NO.	DESCRIPTION	MARS PACK	CASE QTY.
93396	5 1/2" utility funnel, 1 pint	75-062	1
93397	7" heavy duty funnel, 2 quart	75-070	1
93398	5 3/4" utility funnel w/screen includes 13" flex extension	75-007	1

MARS Grease Guns

Plews grease guns allow one hand operation and are perfect for hard to reach jobs. Precision pump develops up to 7000 p.s.i. Easy three-way loading by standard 14 oz. cartridge or suction filled. There is a head cap port for adding air bleeder or bulk loader fitting. Available in two different styles. Both feature tough all-steel construction with rugged baked enamel finish and tough zinc plated handles. New non-slip knurl on barrel allows for positive grip.

The mini grease gun kit is a compact "tool box" size grease gun that goes where other grease guns can't.

Features include:

- Zinc die cast head cap
- Pistol grip for easy one hand operation combined with heavy duty performance
- Uses standard 3 oz. cartridge
- Kit includes gun with rigid pipe and coupler and one 3 oz. multi purpose grease cartridge

MARS #93353 is a general purpose grease gun with professional features. This grease gun offers 2 way loading: 14 oz. cartridge or suction. The lever action gun includes 5-3/8" pipe and coupler. Develops up to 6,000 PSI. Durable baked enamel finish.

MARS #93355, professional grease gun features variable/short stroke for easy use in confined areas. This lever action gun provides an air bleeder and bulk loader fitting for 3-way loading (14 oz. cartridge, bulk or suction). Grease gun includes 5-3/8" pipe and coupler. Plated lever with comfortable oversized grip is also featured. Develops up to 10,000 PSI.



MARS NO.	DESCRIPTION	MARS PACK	CASE QTY.
93350	Pistol grease gun, 12" hose	30-416	1 5
93351	Pistol grease gun, with pipe ass'y	30-300	1 5
93352	Mini grease gun kit, 3 oz.	30-132	1 10
93353	Lever action grease gun, 14 oz.	30-200	1 10
93355	Professional grease gun, 14 oz.	30-475	1 10

MARS Multi Purpose Grease

Plews multi-purpose lithium grease is a long lasting, hard working formula which delivers high performance in a wide range of heavy duty applications. NLG1 #1-1/2, drop point 350° F.



MARS NO.	DESCRIPTION	MARS PACK	CASE QTY.
93361	Multi purpose cartridge, 14 oz.	11-310	1 40
93360	Multi purpose cartridge, 3 oz./3 pk	11-312	1 12

MARS Lubrication Accessories

Standard Coupler

Standard jaw-type coupler features spring-loaded ball check valve. Fits all 1/8" NPT threads. For hand operated lube equipment only. Recommended working pressure is 4,500 PSI. Length 1-7/16", width 5/8".

Heavy Duty Coupler

For hand operated grease guns only. Recommended working pressure is 6,000 PSI. All steel construction. Fits all 1/8" NPT threads. Four jaws. Length 1-1/2", width 3/4".

Standard Duty Flexible Grease Hoses

For use on hand operated grease guns only. Steel 1/8" NPT male fittings on each end. Recommended working pressure is 5,000 PSI.



MARS NO.	DESCRIPTION	MARS PACK	CASE QTY.
93365	Standard grease gun coupler	05-031	1 10
93366	Heavy duty grease gun coupler	05-035	1 10
93367	Heavy duty grease hose, 12"	10-212	1 10
93369	Heavy duty grease hose, 18"	10-219	1 10

Accessories

Epoxy-Stik™

- Cures rock hard with no shrinkage
- Safe on portable water systems
- Withstands temperatures up to 250° F
- Hardens in 5-10 minutes, full cure in 24 hours
- Can be applied under water
- After 1 hour can be drilled, tapped, filed, sawed, sanded and painted
- Made in USA



LA-CO.

MARS NO.	DESCRIPTION	MARS PACK	CASE QTY.
95522*	4 oz. stick	24	24

* Packaged in one dozen per display box

Sharpie® #15 Fiber Tip Marker (Dura-Ink #15)

- Fine tip
- Ideal for fine line marking
- Extra tough tip, won't spread
- Smear resistant, water resistant
- Marks on metal, wood, cardboard, paper, plastic, glass, etc.
- For identification of parts, layout work, marking cartons and crates
- Meets U.S. Fed. Spec. TT-1-544



LA-CO.

MARS NO.	DESCRIPTION	MARS PACK	CASE QTY.
95488	Black	12	72

Valve Action™ Paintmarker

- Marking range: -50° to 150° F / -46° to 66° C
- Marks w/ real paint, dries in minutes
- Valve action nib releases paint as needed for continuous marking
- Marks on all surfaces including: metal, wood, glass, plastic, rubber, cardboard and paper
- Lead - free, low halogens
- The fiber nib is replaceable to assure complete use of each marker
- Durable metal barrel
- Meets California VOC regulations

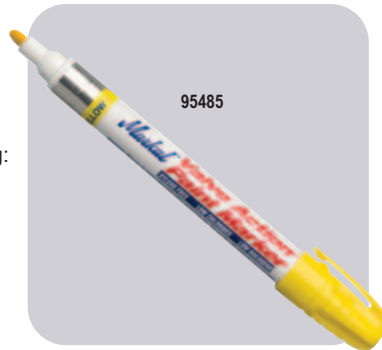

LA-CO.

MARS NO.	DESCRIPTION	MARS PACK	CASE QTY.
95480	Black	12	48
95481	Red	12	48
95485	Yellow	12	48

Dura-Ink® Fiber Tip Markers

- Larger ink supply, heavy duty metal barrel
- Water - resistant, fade - resistant
- Chisel tip makes fine lines or broad marks
- Meets Fed. Spec. TT-1- 544
- Use on cardboard, wood, metal, paper, ceramics, glass, etc.
- For identification of equipment, marking shipping cartons, sign making, etc.
- #20 is medium size, #25 is king size



LA-CO.

MARS NO.	DESCRIPTION	MARS PACK	CASE QTY.
95500	Dura -Ink® #25 - Black	12	48
95516	Markal Dura-Ink® #25 Black Marker (2-pk)	1	24
95519	Dura-Ink® #15 - Black	1	36

Pipetite-Stik®

- Efficient way to seal pipe
- Pressure: 350 PSI (24 BAR) for gas 2,000 PSI (136 BAR) for liquid
- Safe, non-toxic, non-drying
- Made in USA



LA-CO.

MARS NO.	DESCRIPTION	MARS PACK	CASE QTY.
95433	Pipetite Stick 1-1/4 oz.	12	144

E-Z Break® Anti-Seize Compound

- Copper-based anti-seize and lubricating compound
- Resists rust and corrosion
- Recommended for coating nuts, bolts, valves, flanges, splines, for easy break out after years of service
- Meets Mil. Spec. Mil-A-907E
- Authorized by USDA for use in federally inspected meat and poultry plants
- Temperature: to 1800° F (982° C)
- Made in USA



LA-CO.

MARS NO.	DESCRIPTION	MARS PACK	CASE QTY.
95472	10 oz. w/brushcap	24	24

Permatex® Adhesives & Sealants

Permatex® PermaPoxy™ 5 Minute General Purpose Epoxy and 30 Minute High Strength General Purpose Epoxy

- Versatile easy to use, clear appearance, 2 part adhesive and filler system. No need to weld or braze
- Fills gaps and will not shrink
- Temperature range -60°F to 180°F (-51°C to 82°C).
- 5 min. general purpose epoxy - permanent strength up to 3400 PSI
- 30 min high strength - permanent strength up to 3500 PSI

Permatex® Super Glue. This formulation was specially designed for a faster, long-lasting bond. It is easily applied and works on non-porous materials including metal, plastics, rubber, vinyl, paper, wood, textiles, and cork gaskets. Permanent transparent bond fills gaps to .004".



MARS NO.	DESCRIPTION	MARS PACK	CASE QTY.
95555	5 Min Epoxy, .84 fl oz	12	12
95556	30 Min Epoxy, .84 fl oz dual syringe	12	12
95557	Super Glue Gel tube, 2 grams	12	12
95558	Super Glue tube, 2 grams	12	12

Permatex® High Performance Thread Sealant

Permatex® Thread Sealants seal and secure metal pipes and fittings by filling the space between threaded metal parts. Cures rapidly to with stand up to 10,000 PSI. By filling the space between threaded metal parts, Thread Sealants cure to a pliable seal to prevent leakage caused by vibration loosening, tape shredding, solvent evaporation, damaged threads, and temperature cycling. Designed for low and high pressure applications, thread Sealants seal instantly for on-line low pressure testing. When fully cured, they seal to the burst strength of most piping systems. Temperature Range:-65°to 300°F



MARS NO.	DESCRIPTION	MARS PACK
95559	High Strength Thread Sealant, white	6

Permatex® Medium Strength Threadlocker BLUE

All-purpose, medium strength threadlocker. Ideal for all nut and bolt applications 1/4" to 3/4" (6mm to 20mm). Eliminates need for stocking expensive lock nuts and lock washers. Locks and seals while preventing parts loosening due to vibration. Protects threads from corrosion. Removable with hand tools for easy disassembly. Conforms to ASTM D 5363 AN0321 (Mil-S-46163A, Type II, Grade N). Threadlockers remain the most reliable way to lock and seal threaded fasteners of all shapes and sizes, before or after assembly.



MARS NO.	DESCRIPTION	MARS PACK
95560	Med Strength Threadlocker Blue, 6 ml tube, carded	12

Permatex® Form-A-Gasket® No. 2 Sealant

Slow-drying, non-hardening sealant designed for sealing cut gaskets and stamped parts. Allows for easy disassembly if required. Temperature range -65°F to 400°F (-54°C to 204°C); resists common shop fluids and fuels. Use where sealing is more important than adhesion.

Suggested Applications: Valve cover gaskets, oil pan gaskets



MARS NO.	DESCRIPTION	MARS PACK
95563	Form-A-Gasket®, 3 oz., tube, carded	12
95564	Form-A-Gasket®, 11 oz., tube, carded	12

Accessories

Permatex® Sensor-Safe Blue RTV Silicone Gasket Maker

Permatex Blue now with low odor formula. Will not foul oxygen sensors. Replaces almost any cut gasket. Makes reliable "formed-in-place" gaskets that resist cracking, shrinking and migrating. Coats pre-cut gaskets to increase reliability. Temperature range -65°F to 500°F (-54°C to 260°C) intermittent; resists auto and shop fluids.



95565

MARS NO.	DESCRIPTION	MARS PACK
95565	Blue RTV Silicone Gasket Maker, 3 oz. tube, carded	12

Permatex® Fast Orange® Fine Pumice Lotion Hand Cleaner

The #1 selling, biodegradable, waterless, petroleum solvent-free hand cleaner that contains no harsh chemicals, petroleum solvents or ammonia that can sting cuts or abrasions. Pure, fresh-smelling natural citrus power does the cleaning. Fortified with aloe, lanolin, glycerin, and other skin conditioners to soothe raw, rough hands. Fine Pumice deep cleans the toughest dirt. Works great on laundry stains (smooth lotion only), scuff marks, tile floors, pet odors and many other household cleaning needs. Readily Biodegradable according to OECD Method 301E



95561

95562

MARS NO.	DESCRIPTION	MARS PACK
95561	Fast Orange Fine Pumice Lotion Hand Cleaner, 15 Fl. oz., squeeze bottle	12
95562	Fast Orange Fine Pumice Lotion Hand Cleaner, Low Profile 1 gallon bottle w/pump	4

CRC Lubricants



CRC products incorporate the SDS(L)TM, a removable safety data sheet printed on the reverse side of the label. With this new labeling system, an SDS is always where you need it the most, right on the product you are using!

CRC 3-36 is a multi purpose lubricant and penetrant that forms a clear film that lubricates and stops corrosion. Its high affinity for metal allows it to penetrate and displace moisture leaving a long lasting rust preventing film. Available in aerosol with a nonflammable CO2 propellant and 360° valve.

CRC Screwloose® Penetrating Oil is a no compromise penetrant that attacks rust and corrosion, penetrating through oxides and soil to free corroded fasteners and mechanical components.

CRC Power Lube® is a unique new lubricant that incorporates a sophisticated additives package with PTFE to provide long lasting protection against friction and wear. It is able to work longer and better than other lubricants under the extremes of pressure and the environment. Unlike most lubricants with PTFE, it contains no chlorinated solvents.

CRC White Lithium grease is a high purity, high quality grade 2 white lithium based grease for superior lubrication. It is truly white, smooth and buttery in consistency for optimum surface coverage. It has both rust and oxidation inhibitors to provide durable lubrication and protection in any application.



MARS NO.	DESCRIPTION	MARS PACK
93208	3-36 Multi Purpose Lubricant, 11 oz.	12
93211	Screwloose® Penetrating Oil, 11 oz.	12
93212	Power Lube® High performance lubricant w/PTFE, 11	12
93214	White Lithium Grease, 10 oz.	12

CRC Specialty Products

The Wasp and Hornet Killer Plus™ is a fast acting, high strength insecticide that kills wasps, hornets, black widow spiders, fire ants and scorpions. Will not damage plastic connectors and other insulating materials. Provides a dense accurate spray that will reach over 20 feet. Excellent for the A/C contractor.

HydroForce™ Glass Cleaner Professional Strength is formulated to clean streak-free – the first time and every time. The ammonia-fortified formula quickly cleans the toughest dirt, dust, fingerprint and haze deposits without leaving unsightly streaks due to residue. HydroForce™ is versatile and safe to use on all glass surfaces. The foaming, ready-to-use formula allows for greater coverage and less run-off when cleaning vertical surfaces. HydroForce™ is biodegradable, non-corrosive, non-flammable and non-abrasive. Let us prove it to you.



MARS NO.	DESCRIPTION	MARS PACK
93226	Wasp and Hornet Killer Plus™, 14 oz.	12
93227	HydroForce Glass Cleaner, 18 oz.	12

CRC Cleaners/Degreasers



CRC Heavy Duty Degreaser is a chlorinated solvent based cleaner/degreaser that is chemically stable and extremely effective in most heavy duty applications. It has no fire or flash point, evaporates quickly with no residue and is non-conductive. New formula contains no ozone depleting compounds. Effectively removes grease, tar, oil, adhesives, etc. to increase operating efficiency.

CRC Industrial Contact Cleaner is designed to quickly and effectively clean sensitive electrical and electronic components. It has no flash point and evaporates quickly, leaving no residue. Contains no CFC's or VOC's

CRC QD Contact Cleaner is an alcohol based precision cleaner that is **100% free of CFC's**. For use on non-energized equipment, it evaporates rapidly and is harmless to most plastics. For use on electrical and electronic components where precision cleaning is necessary.

The CRC Contact Cleaner 2000™ is a revolutionary precision cleaning solvent designed to meet today's environmental challenges. This high purity solvent is a new generation HCFC and does not exhibit the same ozone depleting properties as conventional CFC solvents. It evaporates rapidly, has no flash point and leaves no residue (may affect some plastics).

CRC Gasket Remover is a solvent based high strength cleaner that effectively loosens and helps remove fiber gaskets, adhesives and sealants. It helps protect equipment surfaces by eliminating damage caused by scraping. Also removes paint and graffiti.



MARS NO.	DESCRIPTION	MARS PACK
93215	Heavy Duty Degreaser, 19 oz.	12
93217	Industrial Contact Cleaner, 14 oz.	12
93218	QD Contact Cleaner, 11 oz.	12
93219	Contact Cleaner 2000™, 14 oz.	12
93222	Gasket Remover, 12 oz.	12

Accessories

CRC Food Grade Silicone

CRC Food Grade Silicone forms a colorless, tasteless, non-toxic and non-staining film that is authorized by the USDA for use in federally inspected meat and poultry plants. Its silicone lubrication film meets FDA specifications for incidental food contact.



93210

MARS NO.	DESCRIPTION	MARS PACK
93210	Food Grade Silicone, 10 oz.	12

CRC RTV Silicone

CRC RTV Silicone Adhesive/Sealants are the perfect way to seal, bond and protect. With the press of the nozzle, a precise bead of high purity silicone is easily applied. No lumps, gaps, bubbles or waste. The package keeps the silicone fresh with the product in the nozzle forming a self sealing plug. Convenient and easy to use.



93236

MARS NO.	DESCRIPTION	MARS PACK
93236	8 oz. clear	12

CRC Corrosion Inhibitors

CRC Zinc-It® Instant Cold Galvanize is a high performance 95% zinc-rich coating that restores hot dipped galvanized properties to ferrous metals. Its sacrificial coating helps fight rust and corrosion creepage with a durable, flexible film.

CRC Belt Dressing extends the life of drive belts by improving traction and allowing runs under



93223

93224

MARS NO.	DESCRIPTION	MARS PACK
93223	Zinc-It®, 13 oz.	12
93224	Belt Dressing, 10 oz.	12

Spray-X Foaming Glass Cleaner



“Safe on Finished or Non-Porous Surface’s”

- The Most Versatile Glass Cleaner Available
- Sprays in Any Position
- Dissolves Dirt, Grease, Grit and Grime
- Heavy-Duty Foam Clings to Vertical Surfaces
- Guaranteed to Leave No Film - "Streak Free"
- Industrial Strength
- Pleasant Scent
- Premium Formula



93298



MARS NO.	DESCRIPTION	CASE QTY
93298	SPRAY-X Glass Cleaner, 19 oz.	12

Industrial All Purpose Spray Enamel



Krylon TOUGH COAT® acrylic alkyd enamels feature a high-solids formula that ensures maximum coverage and performance. Tough Coat delivers the ultimate in protection, durability, high gloss, color retention and applies with a smooth even coverage. Fast-drying to the touch in 15 minutes. Ideal for light to heavy duty painting projects both indoors & outdoors.



78976

MARS NO.	DESCRIPTION	REFRIG. ID #	CASE QTY.
78976	Machinery light gray	R-23	6
78987	Machinery dark gray	R-123	6
78981	OSHA white (gloss)	R-12, R-406A	6
78982	White (flat)		6
78983	OSHA black (gloss)		6
78984	Black (flat)		6
78985	Aluminum		6

Pipeseal

Pipeseal is a unique multi-component epoxy designed to quickly and permanently patch, seal and repair cracks, holes and leaks in all types of pipe.

Seals Holes in Pipe to Full Pressure in Under Five Minutes!

- Works on all types of pipes including copper, steel, lead, cast iron and aluminum.
- Heat activated - Hardens fully in less than 1 minute.
- Withstands pressures up to 1200 PSI.
- No wrap/plug required.
- Suitable for refrigerant lines.
- Extreme chemical resistance
- 100% solids - No VOCs
- Permanently seals holes of up to 1/4 in. in diameter.

INSTRUCTIONS:

- 1 Prepare Surface around pipe hole/crack with sand paper or file.
- 2 Remove clip and cut-off the end with the clear material and apply entire content to mixing surface; ensure mixing surface is not porous.
- 3 Thoroughly mix entire contents.
- 4 Apply to pipe with a wooden stick or trowel.
- 5 Cover a 2-inch-wide area around pipe hole/crack.
- 6 Apply heat with a heat gun/hair dryer (approx. 140°) until Pipe seal cures and hardens (usually within 1minute).



MARS NO.	DESCRIPTION	MARS PACK	CASE QTY.
93629	Pipeseal	1	12

Chapin Sprayers & Accessories



MARS #79067, 2 gallon (1.5 gallon usable) polyethylene sprayer is a high density sprayer that resists breaking, leaking and chemical corrosion. This sprayer has a polymer shut off with lock on feature and a polymer nozzle that adjusts from fine spray to 30' stream, with a poly/brass extension that rotates 360°. Reinforced 36" hose resists crimping, cracking and leaking.

The Chapin acid sprayer is the ideal sprayer for cleaning and degreasing air conditioning coils, engines and many other uses. This 2 gallon (1.5 gallon usable) heavy-duty polyethylene tank features a new built-in relief valve/pressure gauge for added safety and polymer shut offs with lock off features to prevent accidental spraying. A 12" extension tube with adjustable poly cone nozzle ensures for better control when spraying chemically active liquids. Sprays coarse stream to fine mist. 42" hose included

MARS #79069, hand held pressure sprayer is a 48 oz. multi purpose sprayer for small areas. Heavy duty, chemical resistant poly tank features adjustable nozzle control for fine mist or straight stream spraying.



MARS NO.	DESCRIPTION	MARS PACK	CASE QTY.
79067	2 gallon polyethylene sprayer	1	1
79068	2 gallon acid sprayer	1	1
79069	48 oz. hand held sprayer	1	1

Accessories

Swan Garden Hoses



MARS #79540, premium rubber hose, provide superior flexibility and pressure capacity. Maximum kink resistance and burst strength make this hose very durable. Handles hot water up to 160°F. Seal-tite™ washerless leakproof coupling.

The professional hot water hose is designed for a wide range of applications requiring hot water use up to 200°F. The heavy duty rubber construction offers maximum wear and abrasion resistance. Industrial style reinforcing for high burst pressure and kink resistant. Seal-tite™ washerless leakproof coupling. All hoses are made in the U.S.A.

WeatherFlex® Hose is an all-weather reinforced garden hose with its popular mint green Clear Tough™ jacket. Its medium duty construction makes it perfect in all seasons by staying pliable in cold weather. Comes with Eco couplings and patented Hose Armour™ to prevent kinking at the spigot.



MARS NO.	DESCRIPTION	MARS PACK	CASE QTY.
79540	Premium rubber - 5/8" x 50'	1	4
79542	Hot water rubber - 5/8" x 50'	1	4
79641	Weatherflex®, All weather - 5/8" x 50'	1	5
79642	Weatherflex®, All weather - 5/8" x 75'	1	5

Gilmour Full Size Pistol Grip Nozzles



Features of Gilmour® Pistol Grip Nozzles

	79582	79583	79584
Nozzle features	chrome	metal plated, full-size	metalized full-size
All brass valve stem with permanent adjusting nut on all			
Hold-open clip on all			
Patented, insul. grip & industrial strength lever	yes	no	no
Unique features	rubber head guard, brass head insert	vinyl molded comfort grip	
Stainless steel spring on all			
Lifetime duck packing seal on all			
Male hose threaded for attaching accessories	yes	yes	yes
Pack carded on all			



MARS NO.	DESCRIPTION	MARS PACK	CASE QTY.
79582	Insulated threaded front	1	24
79583	Vinyl cushioned grip	1	24
79584	Metalized threaded front	1	48
79560	Hose washers, fits 5/8" hoses, 20/pk	1	1

Custom Leather Craft Products

Professional contractors require professional tools and accessories. Carrying a CLC Softside Tool Carrier is like owning a workshop to go. Loads of pockets, rugged polyester fabric, reinforced bottom panels, heavy duty stitching and bar tacking at critical stress points are features that make CLC a requested brand.



MARS NO.	DESCRIPTION	MARS PACK
79279	25 Pocket Tool Pouch • 7" x 5-1/2" multi compartment tray slides into bottom of pouch • Box shaped design prevents tipping • Padded carrying handle and adjustable shoulder strap • 8"L x 8"W x 17"H	1
79280	15 Pocket, 16" Center Tray Tool Bag • 13-1/2" x 9" multi compartment tray stores in middle of bag • 8 pockets outside and 7 pockets inside • Padded carrying handle and adjustable shoulder strap • 16"L x 9"W x 9"H	1
79281	4 Pocket Tool Holder • Hang, strap, or clip on workbelts, suspenders, or pants • Securely holds small tools or accessories	1
79284	5 pocket tool Holder • Hang, strap, or clip on workbelts, suspenders, or pants • Securely holds small tools or accessories	1
79282	23 Pocket Large Tool Carrier • 11" x 6" multi compartment plastic tray that slides into the bottom of the carrier • 16 multi use outside pockets and 7 inside to organize tools & accessories • Box shaped design prevents tipping • 11"L x 10"W x 19"H	1
79287	Plastic Cap Swivel Kneepads • One size fits all • Exclusive grooved cap design prevents thread abrasion • Foam padded with easy on/off hook and loop fasteners	1
79288	Work Crew Gloves-L	1
79289	Work Crew Gloves-XL • Synthetic leather palm is tough, soft, and comfortable • Lycra side panels provide flexibility • Spandex back ensures snug fit	1
79277	75 Pocket-Tool Backpack • 7"x 5" multi compartment plastic tray included • Adjustable padded shoulder straps and carry handles • 13"W x 17-1/2"H x 9"D	1

Tool Boxes

All Plano tool boxes and stowaway boxes are constructed of premium quality impact resistant plastics. Solid brass hardware and sturdy ABS drawbolt type latches, withstands rugged wear. All boxes are made in the U.S.A. and have a lifetime warranty!

The Plano Tote-More®, MARS #79368, features a multi compartment drawer and convenient handle for portability. Open top for easy access. Unit measures 14 3/4" L x 9 1/8" W x 6 7/8" H.



* Tools and accessories not included

MARS NO.	DESCRIPTION	MARS PACK
79368	Tote More® w/draw - gray/black	4

Plano Tool Boxes



* Tools and accessories not included

MARS NO.	DESCRIPTION	MARS PACK
79643	Clear StowAway 18 Fixed Compartments, 10.75" x 7.25" x 1.75"	6
79644	Clear StowAway - 5 to 9 Adj. Compt. Pro-Latch, 1' Deep Storage, 9.13" x 5.00" x 1.25"	6
79645	Graphite Gray & Black 16" Tool Box with bulk storage space and tray, Removable StowAway Organizer built into the top, 16" x 9.5" x 7.5"	4
79646	Graphite Gray & Black 20" tool box with bulk storage space and tray, Heavy Duty handle, 20.25" x 10.88" x 9.125"	4
79647	Graphite Gray & Iron Yellow 22" tool box with extra deep storage space and tray, 21.31" x 12.5" x 13.5"	1

Stowaways - Plastic

MARS stowaway boxes are ideal for the professionals or do-it-yourselfers. These utility boxes hold bolts, screws, washers, bits, solderless terminals and many other small items. MARS #79378 has 6-18 adjustable compartments and measures 11" L x 7 1/4"W x 1 3/4"H.

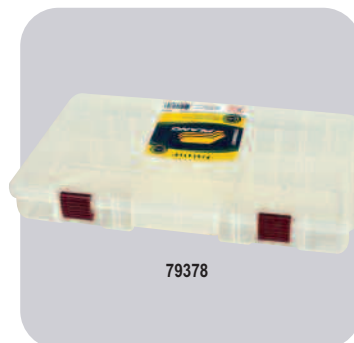

79378

MARS NO.	DESCRIPTION	MARS PACK
79378	6-18 adj. stowaway box - translucent gray, 11.0" x 7.25" x 1.75"	6

Storage Bins

- Heavy duty bins securely stack on top of each other, sit on shelving and hang from racks, panels, rails and carts
- Anti slide stop prevents stacked bins from shifting forward
- Guaranteed not to crack or break under normal load conditions
- Sturdy one piece construction is water, rust and corrosion proof.
- Large front label are for easy coding and scanning
- Curved bottom hopper makes it easy to retrieve small parts



79764

MARS NO.	DESCRIPTION	MARS PACK
79764	12" Blue Shelf Bin 11 5/8" L x 4 1/8" W x 4" H	24
79765	12" Blue Shelf Bin 11 5/8" L x 6 5/8" W x 4" H	12
79766	12" Blue Shelf Bin 11 5/8" L x 8 3/8" W x 4" H	12

Nipple Caddies

- Nipple caddies are designed to help keep you organized
- Durable caddies are constructed of corrosion- and rust-resistant polyethylene
- Designed to hold nipples and keeps them out of water and other liquids
- Drain holes in bottom allows caddy to drain
- Strong enough to take the abuse yet half the weight of metal
- Tall (with handle in up position)



79245
79246

MARS NO.	DESCRIPTION	MARS PACK
79245	1/2" Nipple Caddy, Holds up to 77 nipples. Outside Dimensions: 11-1/4" x 7-3/4" x 8-3/4"	4
79246	3/4" Nipple Caddy, Holds up to 66 nipples. Outside Dimensions: 13-3/4" x 8" x 8-3/4"	4

Accessories

**MARS Clipboards
And Formholders**



MARS aluminum Style A Formholder is versatile, efficient and easy to use. It can be used by both left and right handed people and will accommodate forms ruled either lengthwise or across the width. The storage compartment below keeps completed forms dry and protected.

The MARS Snapaks are very popular aluminum formholders that accommodate loose forms or sales books. Unit opens like a book. Clipboard is included on inside front cover. A hinged aluminum strap on inside back cover holds copies or sales books securely in place. The entire holder folds into a compact protective box to keep forms safe and dry.

The MARS #79558 Redi-Rite is a clipboard on a box. This is the holder to have when you need to carry many forms. Extra storage capacity. All aluminum construction.



- Made from durable RECYCLED aluminum with at least 30% post-consumer waste
- Made in the USA

MARS NO.	DESCRIPTION		CASE QTY.
79552	"A" formholder	8-1/2" x 12"	12
79555	Snapak	8-1/2" x 12"	12
79558	Redi-Rite	8-1/2" x 12"	6

